



CITEL



New Surge Protectors ranges

AC / DC



CITEL

www.citel.fr

OUR OBJECTIVE

the safety of your equipment for 80 years



A LONG HISTORY...

As a family company, our philosophy since its creation and still today has been to offer innovative and reliable surge protectors to be the closest possible to the market demand. With our international presence (6 subsidiaries in the world), our testing laboratories (3 sites: France, USA, China), our R & D (cutting edge technology and innovation), our products (reliability, robustness, certification), our goal is to ensure the safety of your equipment and that for 80 years.

1937

CITEL founded



1985

CITEL USA



1988

CITEL Germany



1992

Reims factory



1996

CITEL Shanghai



Factory & Sales

1944

Manufacture of the first surge arrester

1988

1st AC modular surge protector



CITEL

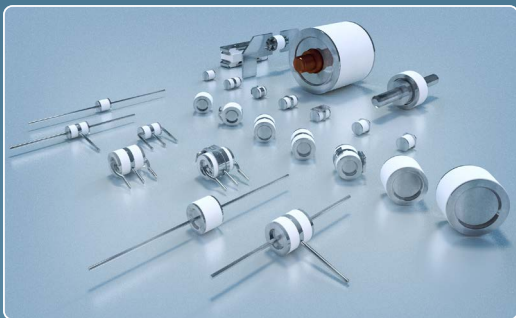

A UNIQUE COMPETENCE

Our only business is the surge protector, we are the only ones to manufacture our own component «gas discharge tube» that we integrate into our surge protection modules. With our know-how we have developed our own range of surge protective devices (SPD), sold to millions of units worldwide. Then in constant search for innovation, we have designed the VG technology, this exclusive and patented technology based on the use of specific gas discharge tube (GSG).

1997

- AC surge protector new range «DS» series
- VG Technology for AC surge protector



2010

CITEL Russia



2012

CITEL India



2017

CITEL Thailand



2012

Implementation of a test laboratory in Reims

2019

AC / DC new ranges

2017

New test laboratory
240 kA
Citel China



CITEL

PROTECT YOUR INSTALLATIONS

against transient overvoltages due to lightning strikes and switching operations



Surge protector is an essential element of the protection strategy of our low voltage and photovoltaic powerline installations. It guarantees the safety and durability of the equipment and therefore contributes to a certain economy.

CITEL has completely renewed its product ranges in order to respond to the different sectors of the market activities and to different standards increasingly demanding.

 Energy	 Photovoltaic	 Led lighting
 Telecom	 Radiocom	 Industry
 Datacenter	 Security	 Internet of things
 GDT & GSG	 Renewable energies	 Smart city



INTERNATIONAL COLLABORATION OF OUR TEAMS



DESIGNED IN EUROPE, USA & CHINA

In collaboration with an industrial design specialist, we have designed and created a more reliable, efficient, ergonomic and practical module to anticipate the needs of our customers.

REALIZED IN FRANCE

Our research and development teams worked in collaboration: research of the best materials, global technical design, tests in our various laboratories, follow-up of the certifications in order to design a range that meets all the international requirements.

MANUFACTURED IN FRANCE AND CHINA

Manufactured, tested, controlled in our own factories in France and China, with strict quality system and our own tools.

CERTIFIED IN GERMANY AND USA

The necessary certification of the new ranges have been carried out in the German and US accredited laboratories. Thanks to our expertise in surge tests, some certification processes have been performed in our own labs, under control of certification bodies.



THE NEW SPD GENERATION

Safer than ever !



SECURITY

The SPD is the safety element of the installation. Its role is to protect the equipment against transient overvoltages without failure. However, the SPD can be subjected to maximum attack conditions and must be able to support them in safety disconnection mode. As the leader of surge protection, we have designed surge protectors that meet the most extreme constraints, beyond the normative requirements.

PERFORMANCE

In order to ensure total safety during the use of our surge protectors, we have focused on :

- Safety disconnection
- Resistance to fire and short circuits
- Mechanical robustness

DESIGN AND ERGONOMICS

With its new design, CITELEL surge protectors are easily identifiable in your installation.

EXCLUSIVE KNOW-HOW

CITELEL is a specialist in the internal components of surge protectors : the Gas Spark Gap (GSG) and the varistors used are of our own design and we adapt them to obtain the best performances.

WARRANTY

Sure of our products, their warranty is extended to 5 years



CITELEL

A NEW TECHNOLOGY

STRENGTHENING OF INTERNAL PARTS

The robustness of the surge protector is essential to support the electromechanical forces generated during the passage of transient currents. We have reduced the internal impedances, improved the contacts, simplified and reinforced the conductive parts.

INCREASED QUALITY OF PLASTIC MATERIALS

The choice of plastic materials is guided by :

- Normative compliance (fire resistance, environment)
- Mechanical robustness
- Aesthetics

INNOVATIVE DESIGN OF INTERNAL DISCONNECTION

The internal disconnection mechanism of the device is the essential element of safety. The new concept, in case of internal heating, allows faster cut-off and reinforced insulation after disconnection.



VG TECHNOLOGY

The exclusive VG Technology by CITEL offers unique hybrid technology and multiple benefits not found in traditional surge protection solutions. The patented design incorporates a **combination of MOV and Gas filled Spark-Gap (GSG) technology to maximize the SPD's performance level and reliability.** VG technology is optimized for robustness and network stability, providing the highest level of protection available.

DISCONNECTION SYSTEM



SPECIFIC GSG
(Gas-filled-spark Gap)

MOV
(Varistors)

BENEFITS OF VG TECHNOLOGY



NO AGEING



NO FOLLOW CURRENT



HIGH SURGE CURRENT CAPABILITY



INCREASED TOV WITHSTAND

BETTER USER EXPERIENCE

Products even more adapted to your needs

DIN RAIL MOUNTING

The modular format and symmetrical DIN rail mounting make the surge protector compliant with all installations.

VOLTAGE SELECTOR

Voltage selector avoid mistakes when replacing module.

CONTACT QUALITY

Surge protectors must conduct very high impulse currents and the plug-in contacts must withstand these constraints. Quality of materials, increased surface area, optimized elasticity and specific surface treatment are used to meet these requirements.

REMOTE SIGNALING

This option, to indicate the state of the arrester remotely, is recommended when the arrester is not easily accessible. In case of safety disconnection of one or more modules, the internal contact switches and can activate any remote device.

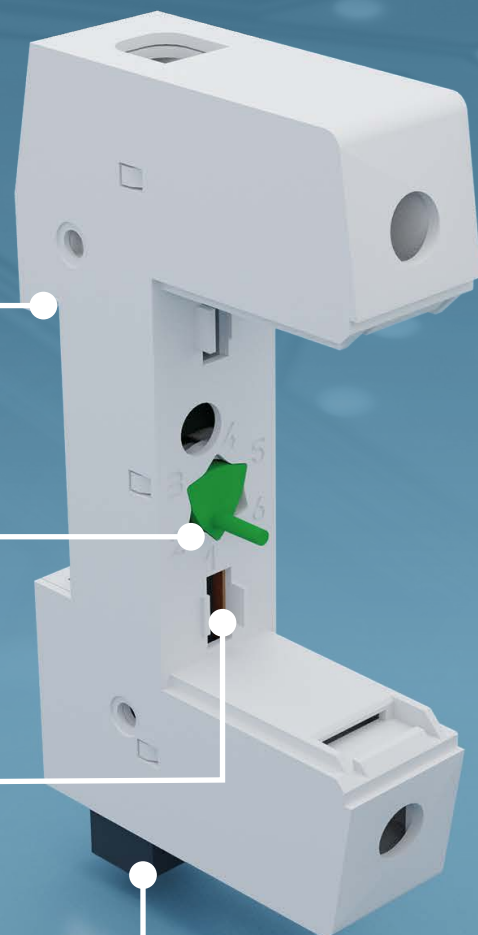

EASY PLUGGABLE

The plugging and unplugging operation is greatly improved thanks to the quality of the module / base contacts. The extraction of the pluggable modules in case of maintenance is largely facilitated.

DISCONNECTION INDICATOR

At the end of its life, the surge protector disconnects from the network and must indicate its state. The indicator clearly informs user about the need to replace the out-of-service module.



Green = OK



Red or Not green = Disconnected

IDENTIFICATION

The colored band on the front of the module makes it possible to identify its use or its type. Grey for AC type 1, Red for AC type 2, Blue for AC type 3, Orange for DC, Green for N/PE branch (GDT).

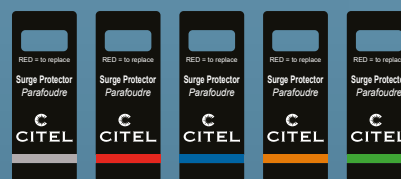

QR CODE

The QR code refers to the product installation instruction allowing a permanent availability of this essential document.



A CERTIFIED RANGE

for the standards of today and tomorrow



STANDARDS

Surge Protection standards are changing and constraints are tightening with each new edition. Several CITELE experts, members of national and international committees, are involved in the development of these standards, to be close to the requirements of the market.

This range has been designed to last and therefore to anticipate future changes in standards.

INTERNAL TESTS

All the technological choices of our ranges were first tested in our testing laboratories, to validate compliance with current standards, but also by providing a functional margin beyond the requirements and anticipate future developments.

CERTIFICATIONS

The final step is certification provided by the official certifications organizations. Thanks to our expertise in surge tests, a part of the process has been performed in our own facilities, under control of official certification bodies.

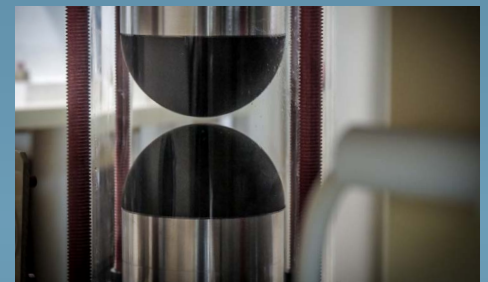

OUR MEANS OF TESTING

In order to test its products internally for standards compliance and to evolve toward greater reliability, CITELE has several test sites (France, USA, China) equipped with:

- Current impulse generators up to 240 kA - 8/20 μ s
- Current impulse generators up to 100 kA - 10/350 μ s
- 1.2/50-8/20 μ s hybrid wave generators up to 20 kV/10 kA
- 400 Vac 3-phase low voltage network-Isc 1.5 kA/phase for coupling with current impulse
- HT fast digital oscilloscopes
- Materials for test environment (damp heat, climate, shock)
- Ultra-fast camera



THE SPD WHICH PROTECTS your equipment and our planet



Besides our constant work on the quality of our products, we take into account the ecological issues of our planet.

This is why CITEL is working to optimize its production equipment in order to reduce the impact on the environment. We have chosen for our new range high quality raw materials.

Our products use **HALOGEN FREE** material and comply with **RoHS** regulations.

CITEL is **ISO 14001** certified and meet the requirements of the **WEEE** directive.

**Production respecting
environmental standards**

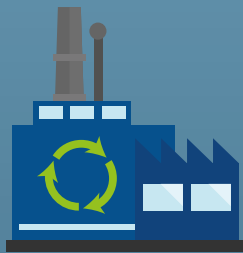

**Purchase of materials
compliant with the
environmental regulations**



**Commitment
for recycling**

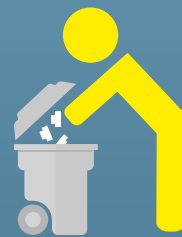

NEW DAC RANGE FOR AC & DC NETWORK



A COMPLETE RANGE WITH MANY OPTIONS

The new ranges of SPDs have been designed by CITEC to answer to all the needs of AC or DC power surge protection in accordance with standards. Type 1+2+3 versions, Compact units, integrated electrical fuse, DC power versions, VG technology...all these features allow a optimized selection of the relevant SPD in close relation with the installation requirements.



COMPACT
VERSION

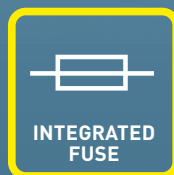

INTEGRATED
FUSE



DC POWER



REMOTE
SIGNALING



CITEC

AC TYPE 1 RANGE

DAC1-13 / DAC1-13VG



OPTIONS



- Extreme duty pluggable Type 1+2+3 or Type 1+2 SPDs designed to protect AC powerline at the main switchboard of an installation equipped with lightning rod (LPS).
- Available in multipolar versions to protect single or 3-phase AC networks
- Equipped with a high efficiency internal disconnecter linked to a front disconnection indicator and a remote signalling feature (option).
- Very high discharge current capability in small dimensions and the best possible behavior to the AC network (no follow current).
- In option : VG technology

AC TYPE 2 RANGE

DAC50 / DAC50VG / DACF25



OPTIONS



- Pluggable surge protectors Type 2 or Type 2+3 designed to protect AC powerline at the main switchboard of the installation.
- Based on high energy varistor equipped with thermal disconnecter and failure indicator to provide a maximum protection efficiency, an high impulse current capability and a improved reliability.
- Available in multipolar version and in several voltages to protect single or 3-phase networks.
- In option : VG technology.
- Available with an internal fuse against short-circuit currents, which avoids the use of a external fuse or circuit-breaker as requested by standard (DACF25).

AC COMPACT RANGE

DAC40C / DAC15C



OPTIONS



- Pluggable compact surge protectors Type 2 or Type 3 designed to protect electrical installation at the main switchboard or at secondary panels.
- Compact format which allow to install it in limited space.
- Based on high energy varistor equipped with thermal disconnecter and failure indicator, guaranteeing a maximum protection efficiency, an high impulse current capability and a improved reliability.
- Available in 2 impulse current versions, in multipolar configuration and in several operating voltages to protect all kind of single or 3-phase AC networks.

DC & DC COMPACT RANGE

DDC / DDCC



OPTIONS



- Type 1+2 or Type 2 pluggable surge protectors designed for equipment connected to DC powerlines.
- Technology based on high energy varistor equipped with thermal disconnection mechanism which offers protection efficiency and a maximal reliability.
- Available in compact version from 12 to 350 Vdc DC powerline.



DAC1-13VG series

Type 1 + 2 + 3 AC Surge Protectors



- VG Technology
- I_n : 20 kA
- I_{imp} : 12.5 kA @ 10/350µs impulse
- I_{total} : 50 kA @ 10/350µs impulse (3L+N)
- Remote signaling (option)
- No leakage current
- Optimized to TOV
- EN 61643-11, IEC 61643-1 certified
- UL1449 ed.4 compliance

Mechanical & Electrical diagrams

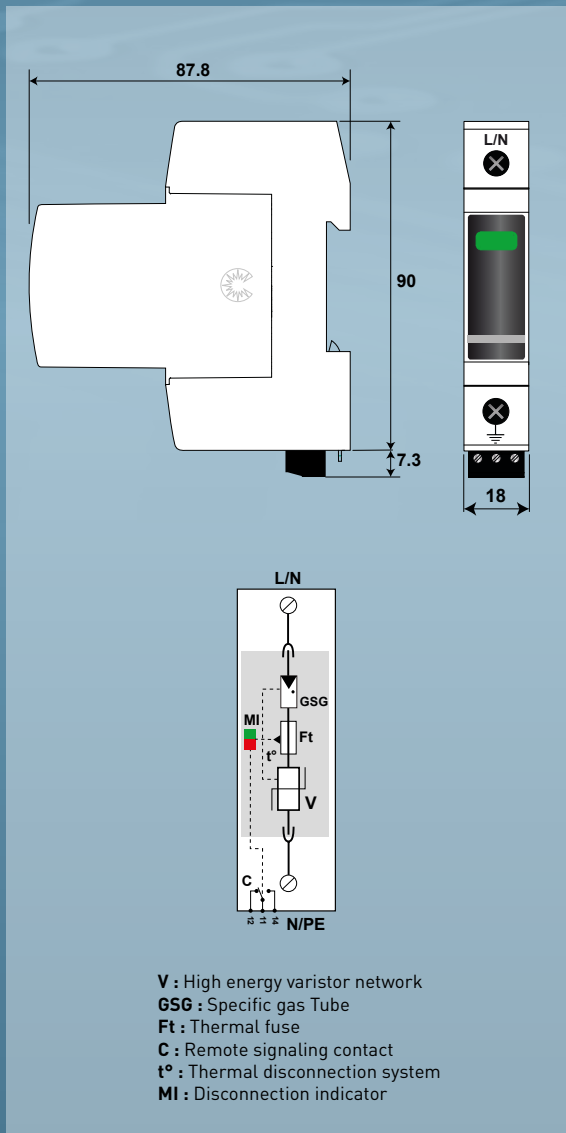

Characteristics

CITEL Model		DAC1-13VG-10-320	DAC1-13VG-10-275	DAC1-13VG-10-150
Description		Type 1+2+3 AC surge protector - one-pole		
Max. AC operating voltage	U_c	320 Vac	275 Vac	150 Vac
Temporary Over Voltage (TOV) characteristic - 5 sec.	UT	335 Vac withstand	335 Vac withstand	180 Vac withstand
Temporary Over Voltage (TOV) characteristic - 120 mn	UT	440 Vac withstand	440 Vac withstand	230 Vac withstand
Residual current - Leakage current at U_c	I_{pe}	None	None	None
Follow current	I_f	None	None	None
Nominal discharge current 15 x 8/20 µs impulses	I_n	20 kA	20 kA	20 kA
Max. discharge current max. withstand @ 8/20 µs by pole	I_{max}	50 kA	50 kA	50 kA
Impulse current by pole max. withstand 10/350µs	I_{imp}	12.5 kA	12.5 kA	12.5 kA
Specific energy by pole	W/R	40 kJ/ohm	40 kJ/ohm	40 kJ/ohm
Withstand on Combination waveform Class III test	U_{oc}	6 kV	6 kV	6 kV
Protection level @ I_n (8/20µs) and 6 kV (1.2/50µs)	U_p	1.5 kV	1.5 kV	1.5 kV
Residual Voltage @ 5 kA (8/20µs)	U_{p-5kA}	0.9 kV	0.7 kV	0.4 kV
Admissible short-circuit current	I_{scsr}	50 000 A	50 000 A	50 000 A
Associated disconnectors				
Thermal disconnector		Internal		
Fuses		125 A min. - 315 A max. - gG type		
Existing upstream ground fault breaker (if any)		Type «S» or delayed		
Mechanical characteristics				
Dimensions		see diagram - 1TE (EN43880)		
Connection to Network		By screw terminals: 2.5-25 mm ² (35mm ² rigid)		
Failsafe Mode		Disconnection from AC network		
Disconnection indicator		1 mechanical indicator Green/Red		
Remote signaling of disconnection output on changeover contact		option DAC1-13VGS-10-320	option DAC1-13VGS-10-275	option DAC1-13VGS-10-150
Max. voltage/current for remote signaling		250 V/0.5 A (AC) / 30 V/2 A (DC)		
Wiring for remote signaling		1.5 mm ² max.		
Mounting		Symmetrical rail 35 mm (EN60715)		
Operating temperature		-40/+85°C		
Protection rating		IP20		
Housing material		Thermoplastic UL94-V0		
Spare unit		MDAC1-13VG-320	MDAC1-13VG-275	MDAC1-13VG-150
Standards				
Certification		IEC 61643-11 / EN 61643-11		
Compliance		UL1449 ed.4		
Part number				
		821730311	821730211	821730111



CITEL

DAC1-13VG series

Type 1 + 2 + 3 AC Multipolar Surge Protectors



DAC1-13VGS-xx-xxx

Maximum operating voltage

Configuration: 10 (1+0), 11 (1+1), 20 (2+0),

30 (3+0), 40 (4+0), 31 (3+1)

«S» Remote signal option

«VG» VG-Technology

«13» Iimp: 12.5 kA

Mechanical & Electrical diagrams

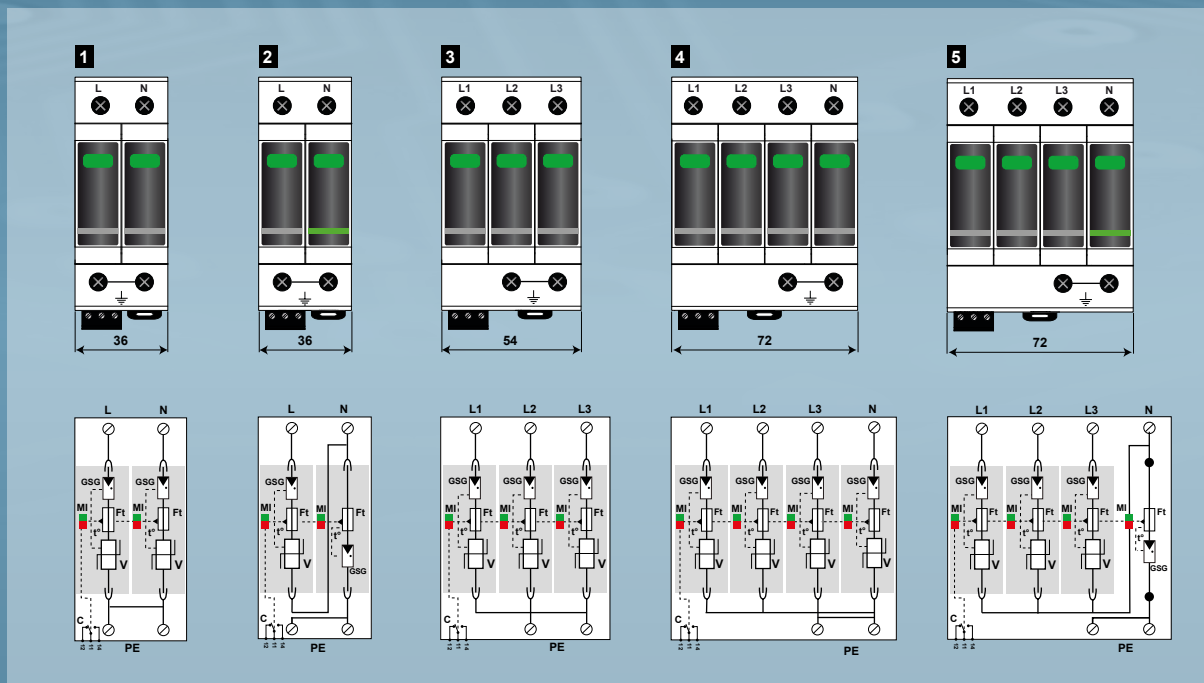

Characteristics

Model	P/N	Network	AC system	Protection Mode	I _{total}	U _p L/PE	U _p L/N	U _p N/PE	Dimension EN43880	Diagram
DAC1-13VG-31-320	821730334	230/400 V 3-Phase+N	TT-TNS System (3+1)	L/N and N/PE	50 kA	-	1.5 kV	1.5 kV	4 TE	5
DAC1-13VG-31-275	821730234	230/400 V 3-Phase+N	TT-TNS System (3+1)	L/N and N/PE	50 kA	-	1.5 kV	1.5 kV	4 TE	5
DAC1-13VG-31-150	821730134	120/208 V 3-Phase+N	TT-TNS System (3+1)	L/N and N/PE	50 kA	-	1.5 kV	1.5 kV	4 TE	5
DAC1-13VG-40-320	821730314	230/400 V 3-Phase+N	TNS System (4+0)	L/PE and N/PE	50 kA	1.5 kV	-	1.5 kV	4 TE	4
DAC1-13VG-40-275	821730214	230/400 V 3-Phase+N	TNS System (4+0)	L/PE and N/PE	50 kA	1.5 kV	-	1.5 kV	4 TE	4
DAC1-13VG-40-150	821730114	120/208 V 3-Phase+N	TNS System (4+0)	L/PE and N/PE	50 kA	1.5 kV	-	1.5 kV	4 TE	4
DAC1-13VG-30-320	821730313	230/400 V 3-Phase	TNC System (3+0)	L/PE	37.5 kA	1.5 kV	-	-	3 TE	3
DAC1-13VG-30-275	821730213	230/400 V 3-Phase	TNC System (3+0)	L/PE	37.5 kA	1.5 kV	-	-	3 TE	3
DAC1-13VG-30-150	821730113	120/208 V 3-Phase	TNC System (3+0)	L/PE	37.5 kA	1.5 kV	-	-	3 TE	3
DAC1-13VG-11-320	821730332	230 V single phase	TT-TN System (1+1)	L/N and N/PE	25 kA	-	1.5 kV	1.5 kV	2 TE	2
DAC1-13VG-11-275	821730232	230 V single phase	TT-TN System (1+1)	L/N and N/PE	25 kA	-	1.5 kV	1.5 kV	2 TE	2
DAC1-13VG-11-150	821730132	120 V single phase	TT-TN System (1+1)	L/N and N/PE	25 kA	-	1.5 kV	1.5 kV	2 TE	2
DAC1-13VG-20-320	821730312	230 V single phase	TN System (2+0)	L/PE and N/PE	25 kA	1.5 kV	-	1.5 kV	2 TE	1
DAC1-13VG-20-275	821730212	230 V single phase	TN System (2+0)	L/PE and N/PE	25 kA	1.5 kV	-	1.5 kV	2 TE	1
DAC1-13VG-20-150	821730112	120 V single phase	TN System (2+0)	L/PE and N/PE	25 kA	1.5 kV	-	1.5 kV	2 TE	1



CITEL

DAC1-13 Series

Type 1 + 2 AC Surge Protectors



- Pluggable Type 1+2 AC power SPD
- In : 20 kA
- Iimp : 12.5 kA @ 10/350µs impulse
- Itotal : 50 kA @ 10/350µs impulse (3L+N)
- Remote signaling (option)
- EN 61643-11, IEC 61643-1 certified
- UL1449 ed.4 compliance

Mechanical & Electrical diagrams

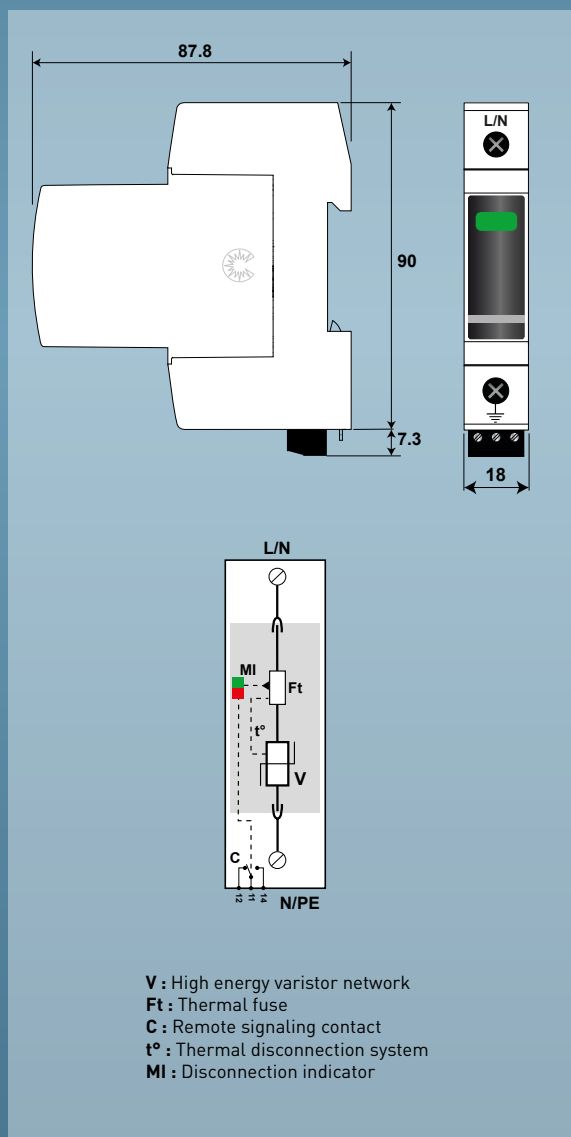

Characteristics

CITEL Model	DAC1-13-10-440	DAC1-13-10-320	DAC1-13-10-275	DAC1-13-10-150
Description	1+2 AC surge protector - 1-pole			
Max. AC operating voltage	Uc 440 Vac	320 Vac	275 Vac	150 Vac
Temporary Over Voltage (TOV) Characteristic - 5 sec.	UT 580 Vac withstand	335 Vac withstand	335 Vac withstand	180 Vac withstand
Temporary Over Voltage (TOV) Characteristic - 120 mn	UT 770 Vac disconnection	440 Vac disconnection	440 Vac disconnection	230 Vac disconnection
Residual current Leakage current at Uc	Ipe < 1 mA	< 1 mA	< 1 mA	< 1 mA
Follow current	If None	None	None	None
Nominal discharge current 15 x 8/20 µs impulses	In 20 kA	20 kA	20 kA	20 kA
Max. discharge current max. withstand @ 8/20 µs by pole	Imax 50 kA	50 kA	50 kA	50 kA
Impulse current by pole max. withstand 10/350µs	Iimp 12.5 kA	12.5 kA	12.5 kA	12.5 kA
Specific energy by pole	W/R 40 kJ/ohm	40 kJ/ohm	40 kJ/ohm	40 kJ/ohm
Protection level @ In (8/20µs)	Up 1.7 kV	1.6 kV	1.3 kV	0.9 kV
Residual volatage @ 5kA (8/20µs)	Up-5kA 1.5 kV	1.2 kV	1 kV	0.6 kV
Admissible short-circuit current	Iscrc 50 000 A	50 000 A	50 000 A	50 000 A
Associated disconnectors				
Thermal disconnector	internal			
Fuses	125 A min. - 315 A max. - gG type			
Existing upstream ground fault breaker (if any)	Type "S" or delayed			
Mechanical characteristics				
Dimensions	see diagram, 1TE, EN 43880			
Connection to Network	By screw terminals: 2.5-25 mm ² (35mm ² rigid)			
Failsafe mode	Disconnection from AC network			
Disconnection indicator	1 mechanical indicator Green/Red			
Remote signaling of disconnection output on changeover contact	option DAC1-13S-10-440	option DAC1-13S-10-320	Option DAC1-13S-10-275	option DAC1-13S-10-150
Max. voltage/current for remote signaling	250 V/0.5 A (AC) / 30 V/2 A (DC)			
Wiring for remote signaling	max 1.5 mm ²			
Mounting	Symmetrical rail 35 mm (EN60715)			
Operating temperature	-40/+85°C			
Protection rating	IP20			
Housing material	Thermoplastic UL94-V0			
Spare unit	MDAC1-13-440	MDAC1-13-320	MDAC1-13-275	MDAC1-13-150
Standards				
Certification	EN 61643-11, IEC 61643-11			
Compliance	UL1449 ed.4			
Part number				
	821710411	821710311	821710211	821710111



DAC1-13 Series

Type 1 + 2 AC Multipolar Surge Protectors



DAC1-13S-xx-xxx

- Maximum operating voltage
- Configuration: 10 (1+0), 11 (1+1), 20 (2+0), 30 (3+0), 40 (4+0), 31 (3+1)
- «S» Remote signal option
- «13» Iimp: 12.5 kA

Mechanical & Electrical diagrams

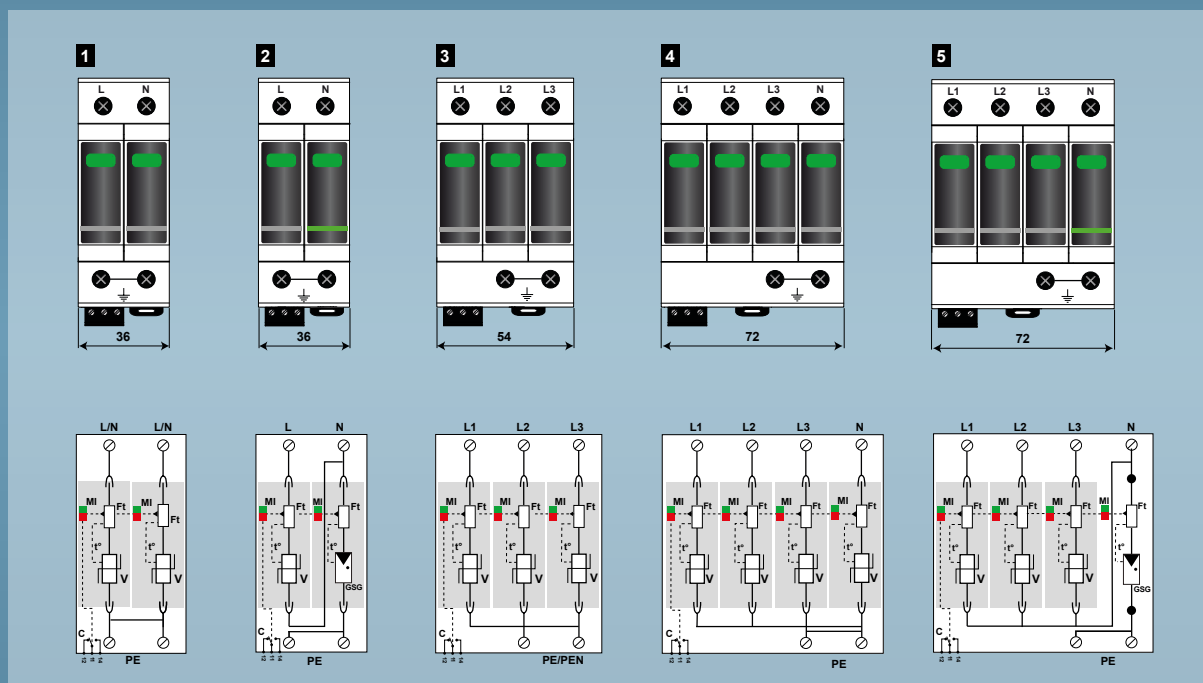

Characteristics

Model	P/N	Network	AC system	Protection Mode	I _{total}	U _p L/PE	U _p L/N	U _p N/PE	Dimension EN43880	Diagram
DAC1-13-31-320	821710334	230/400 V 3-Phase+N	TT-TNS System (3+1)	L/N and N/PE	50 kA	-	1.6 kV	1.5 kV	4 TE	5
DAC1-13-31-275	821710234	230/400 V 3-Phase+N	TT-TNS System (3+1)	L/N and N/PE	50 kA	-	1.3 kV	1.5 kV	4 TE	
DAC1-13-31-150	821710134	120/208 V 3-Phase+N	TT-TNS System (3+1)	L/N and N/PE	50 kA	-	0.9 kV	1.5 kV	4 TE	
DAC1-13-40-440	821710414	230/400 V 3-Phase+N	IT System (4+0)	L/PE and N/PE	50 kA	1.7 kV	-	1.7 kV	4 TE	
DAC1-13-40-320	821710314	230/400 V 3-Phase+N	TNS System (4+0)	L/PE and N/PE	50 kA	1.6 kV	-	1.3 kV	4 TE	
DAC1-13-40-275	821710214	230/400 V 3-Phase+N	TNS System (4+0)	L/PE and N/PE	50 kA	1.3 kV	-	1.3 kV	4 TE	4
DAC1-13-40-150	821710114	120/208 V 3-Phase+N	TNS System (4+0)	L/PE and N/PE	50 kA	0.9 kV	-	0.9 kV	4 TE	3
DAC1-13-30-440	821710413	230/400 V 3-Phase	IT System (3+0)	L/PE	37.5 kA	1.7 kV	-	-	3 TE	3
DAC1-13-30-320	821710313	230/400 V 3-Phase	TNC System (3+0)	L/PE	37.5 kA	1.6 kV	-	-	3 TE	3
DAC1-13-30-275	821710213	230/400 V 3-Phase	TNC System (3+0)	L/PE	37.5 kA	1.3 kV	-	-	3 TE	3
DAC1-13-30-150	821710113	120/208 V 3-Phase	TNC System (3+0)	L/PE	37.5 kA	0.9 kV	-	-	3 TE	3
DAC1-13-11-320	821710332	230 V single phase	TT-TN System (1+1)	L/N and N/PE	25 kA	-	1.6 kV	1.5 kV	2 TE	2
DAC1-13-11-275	821710232	230 V single phase	TT-TN System (1+1)	L/N and N/PE	25 kA	-	1.3 kV	1.5 kV	2 TE	2
DAC1-13-11-150	821710132	120 V single phase	TT-TN System (1+1)	L/N and N/PE	25 kA	-	0.9 kV	1.5 kV	2 TE	2
DAC1-13-20-440	821710412	230 V single phase	IT System (2+0)	L/PE and N/PE	25 kA	1.7 kV	-	1.7 kV	2 TE	1
DAC1-13-20-320	821710312	230 V single phase	TN System(2+0)	L/PE and N/PE	25 kA	1.6 kV	-	1.6 kV	2 TE	1
DAC1-13-20-275	821710212	230 V single phase	TN System(2+0)	L/PE and N/PE	25 kA	1.3 kV	-	1.3 kV	2 TE	1
DAC1-13-20-150	821710112	120 V single phase	TN System (2+0)	L/PE and N/PE	25 kA	0.9 kV	-	0.9 kV	2 TE	1



ZPAC1 Series

Type 1+2+3 AC surge protector - 3-phase+N



- Type 1+2+3 AC SPD for 40 mm busbar systems
- Ultra fast and error-free mounting
- Pluggable modules
- VG Technology
- In : 20 kA
- Iimp : 12.5kA or 8 kA
- Iimp total : 50 kA or 32 kA
- No leakage current
- Optimized to TOV
- EN 61643-11 / IEC 61643-11 certified
- UL1449 ed. 4 compliance
- VDE-AR-N 4100 compliance (use of Type 1 overvoltage protection devices (SPD) in main power supply systems)

ZPAC1-xxVG-xx-xxx

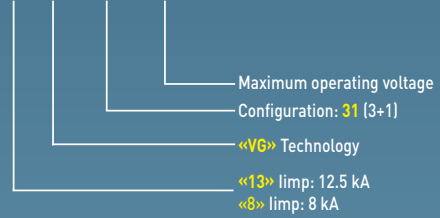

Mechanical & Electrical diagrams

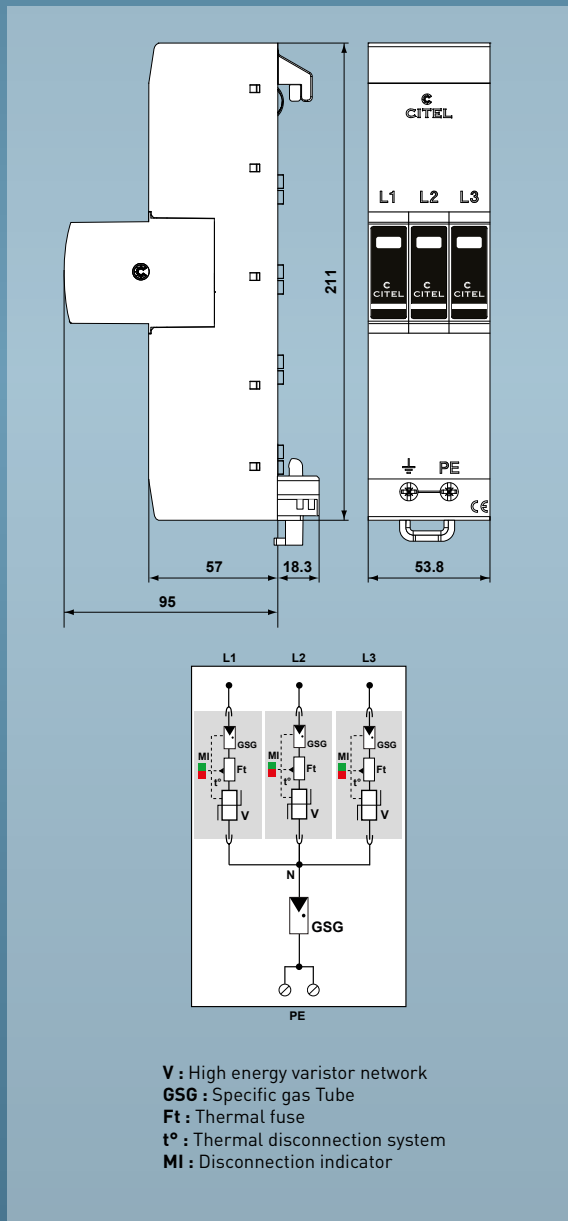

Characteristics

CITEL model		ZPAC1-13VG-31-275	ZPAC1-8VG-31-275
Network	Un	230/400 V 3L+N	230/400 V 3L+N
Max. AC operating voltage	Uc	275 Vac	275 Vac
Frequency	fn	0 - 100 Hz	0 - 100 Hz
Temporary over voltage (TOV) characteristics - 5 sec.	UT	335 Vac withstand	335 Vac withstand
Temporary Over Voltage (TOV) characteristics - 120 mn	UT	440 Vac withstand	440 Vac withstand
Temporary Over Voltage N/PE (TOV HT)	UT	1200 V/300 A/200 ms withstand	1200 V/300 A/200 ms withstand
Residual current - Leakage current at Uc	Ipe	None	None
Follow current	If	None	None
Nominal discharge current <i>15 x 8/20µs impulses</i>	In	20 kA	20 kA
Maximum discharge current <i>max withstand @ 8/20 µs by pole</i>	I _{max}	50 kA	50 kA
Impulse current <i>max withstand @ 10/350 µs by pole</i>	I _{imp}	12.5 kA	8 kA
Specific energy	W/R	40 kJ / Ohm	16 kJ / Ohm
Total lightning current - @ 10/350µs total	I _{total}	50 kA	32 kA
Withstand on combination waveform <i>Class III test</i>	Uoc	6 kV	6 kV
Protection mode		CM/DM*	CM/DM*
Protection level <i>@ In (8/20µs) and (1,2/50µs)</i>	Up L/N	1.5 kV	1.5 kV
	Up N/PE	1.5 kV	1.5 kV
Protection level @ In	Up-In	1 kV	1 kV
Admissible short-circuit current	I _{sc}	50 000 A	50 000 A
Associated disconnectors			
Thermal disconnector		internal	
Existing upstream fuses		Fuses Type gG - 160 A max.	
Mechanical characteristics			
Dimensions		See diagram - 3 TE, EN 43880	
Connection to network		by 40 mm busbar and wire for PE: 10-50 mm ²	
Disconnection indicator		1 mechanical indicator by pole, Green/Red	
Failure behavior		Disconnection from the network	
Mounting		40 mm busbar systems	
Operating temperature		-40 °C/+85 °C	
Protection rating		IP20	
Housing material		Thermoplastic UL-94-V0	
Standard			
Certification		EN61643-11, IEC 61643-11	
Compliance		UL1449 ed.4	
Part number			
		64004	64006

DAC50VG Series

Type 2 + 3 AC Surge Protectors



- Type 2 + 3 AC surge protectors
- VG Technology
- In: 20 kA
- No leakage current
- Optimized to TOV
- Remote signaling (option)
- IEC 61643-11, EN 61643-11 certified
- UL1449 ed.4 compliance

Mechanical & Electrical diagrams

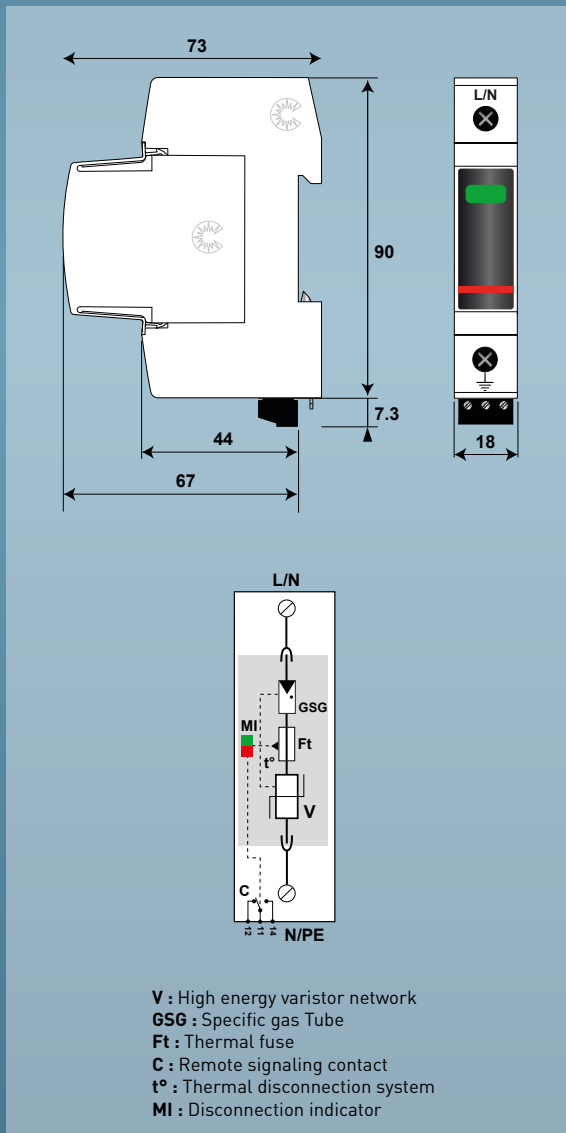

Characteristics

CITEL Model	DAC50VG-10-320	DAC50VG-10-275	DAC50VG-10-150
Description	Type 2 AC surge protector - one-pole - pluggable		
Maximum AC operating voltage	Uc 320 Vac	275 Vac	150 Vac
Temporary Over Voltage (TOV) Characteristic - 5 sec.	UT 335 Vac withstand	335 Vac withstand	180 Vac withstand
Temporary Over Voltage (N/PE TOV) Characteristic - 120mn	UT 440 Vac disconnection	440 Vac disconnection	230 Vac disconnection
Residual current Leakage current at Uc	Ipe None	None	None
Follow current	If None	None	None
Nominal discharge current 5 x 8/20 μs impulses	In 20 kA	20 kA	20 kA
Maximum discharge current max. withstand 10/350μs by pole	I _{max} 50 kA	50 kA	50 kA
Withstand on combination waveform - Class III test	Uoc 6 kV	6 kV	6 kV
Protection level @ In (8/20μs) and 6 kV(1.2/50μs)	Up 1.5 kV	1.5 kV	1.5 kV
Residual voltage @ 5 kA (8/20μs)	Up-5kA 0.9 kV	0.7 kV	0.4 kV
Admissible short-circuit current	I _{scrr} 50 000 A	50 000 A	50 000 A
Associated disconnectors			
Thermal disconnector	internal		
Fuses	50 A min. - 160 A max. - gG Type		
Existing upstream ground fault breaker (if any)	Type "S" or delayed		
Mechanical characteristics			
Dimensions	see diagram - 1 TE (EN43880)		
Connection to Network	By screw terminals: 2.5-25 mm ² (35mm ² rigid)		
Failsafe mode	Disconnection from AC network		
Disconnection indicator	1 mechanical indicator Green/Red		
Remote signaling of disconnection output on change over contact	option DAC50VGS-10-320	option DAC50VGS-10-275	option DAC50VGS-10-150
Max. voltage/current for remote signaling	250 V/0.5 A (AC) / 30 V/2 A (DC)		
Wiring for remote signaling	max. 1.5 mm ²		
Mounting	Symmetrical rail 35 mm (EN60715)		
Operating temperature	-40/+85°C		
Protection rating	IP20		
Housing material	Thermoplastic UL94-V0		
Spare unit	MDAC50VG-320	MDAC50VG-275	MDAC50VG-150
Standards			
Certification	EN 61643-11 / IEC 61643-11		
Compliance	UL1449 ed.4		
Part number			
	821130311	821130211	821130111



DAC50VG Series

Type 2+3 AC Multipolar Surge Protectors



DAC50VGs-xx-xxx

- Maximum operating voltage
- Configuration: 10 (1+0), 11 (1+1), 20 (2+0), 30 (3+0), 40 (4+0), 31 (3+1)
- «S» Remote signal option
- «VG» VG Technology
- «50» I_{max}: 50 kA

Mechanical & Electrical diagrams

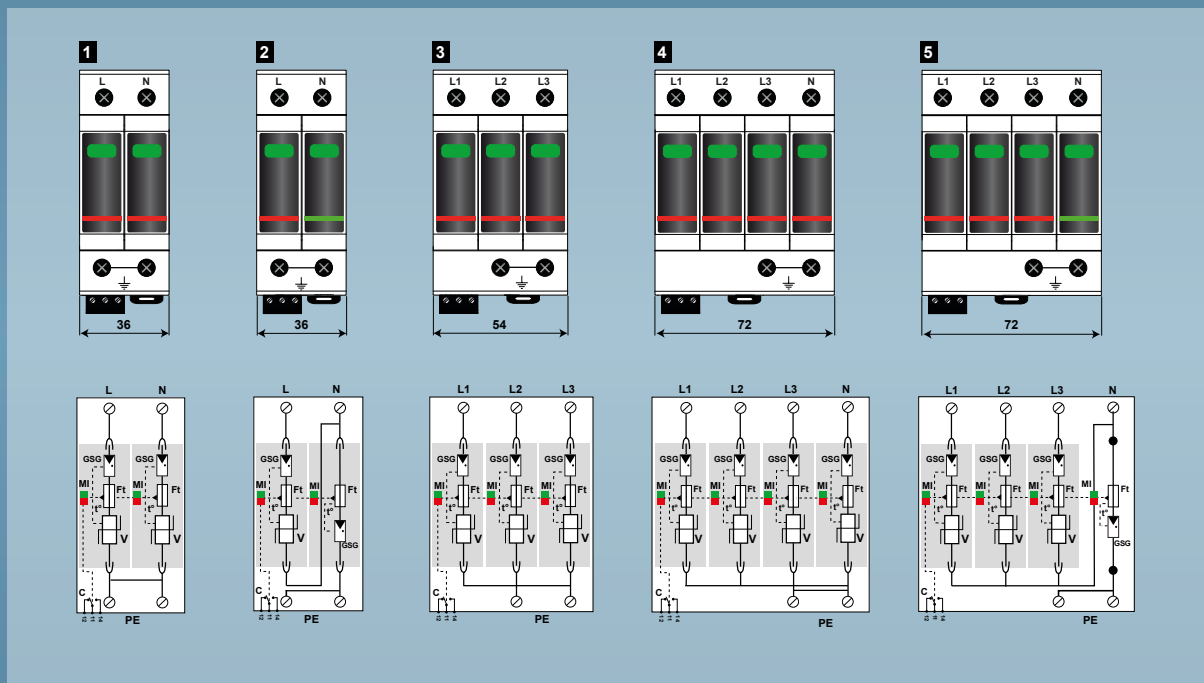

Characteristics

Model	P/N	Network	AC system	Protection mode	Up L/PE	Up L/N	Up N/PE	Dimension EN43880	Diagram
DAC50VG-31-320	821130334	230/400 V 3-Phase+N	TT-TNS System (3+1)	L/N and N/PE	-	1.5 kV	1.5 kV	4 TE	5
DAC50VG-31-275	821130234	230/400 V 3-Phase+N	TT-TNS System (3+1)	L/N and N/PE	-	1.5 kV	1.5 kV	4 TE	5
DAC50VG-31-150	821130134	120/208 V 3-Phase+N	TT-TNS System (3+1)	L/N and N/PE	-	1.5 kV	1.5 kV	4 TE	5
DAC50VG-40-320	821130314	230/400 V 3-Phase+N	TNS System (4+0)	L/PE and N/PE	1.5 kV	-	1.5 kV	4 TE	4
DAC50VG-40-275	821130214	230/400 V 3-Phase+N	TNS System (4+0)	L/PE and N/PE	1.5 kV	-	1.5 kV	4 TE	4
DAC50VG-40-150	821130114	120/208 V 3-Phase+N	TNS System (4+0)	L/PE and N/PE	1.5 kV	-	1.5 kV	4 TE	4
DAC50VG-30-320	821130313	230/400 V 3-Phase	TNC System (3+0)	L/PE	1.5 kV	-	-	3 TE	3
DAC50VG-30-275	821130213	230/400 V 3-Phase	TNC System (3+0)	L/PE	1.5 kV	-	-	3 TE	3
DAC50VG-30-150	821130113	120/208 V 3-Phase	TNC System (3+0)	L/PE	1.5 kV	-	-	3 TE	3
DAC50VG-11-320	821130332	230 V Single Phase	TT-TN System (1+1)	L/N and N/PE	-	1.5 kV	1.5 kV	2 TE	2
DAC50VG-11-275	821130232	230 V Single Phase	TT-TN System (1+1)	L/N and N/PE	-	1.5 kV	1.5 kV	2 TE	2
DAC50VG-11-150	821130132	120 V Single Phase	TT-TN System (1+1)	L/N and N/PE	-	1.5 kV	1.5 kV	2 TE	2
DAC50VG-20-320	821130312	230 V Single Phase	TN System (2+0)	L/PE and N/PE	1.5 kV	-	1.5 kV	2 TE	1
DAC50VG-20-275	821130212	230 V Single Phase	TN System (2+0)	L/PE and N/PE	1.5 kV	-	1.5 kV	2 TE	1
DAC50VG-20-150	821130112	120 V Single Phase	TN System (2+0)	L/PE and N/PE	1.5 kV	-	1.5 kV	2 TE	1

DAC50 Series

Type 2 AC surge protector



- Type 2 AC Surge Protector
- In: 20 kA
- Imax: 50 kA
- Pluggable module for each phase
- Remote signaling (option)
- IEC 61643-11, EN 61643-11 certified
- UL1449 ed.4 compliance

Mechanical & Electrical diagrams

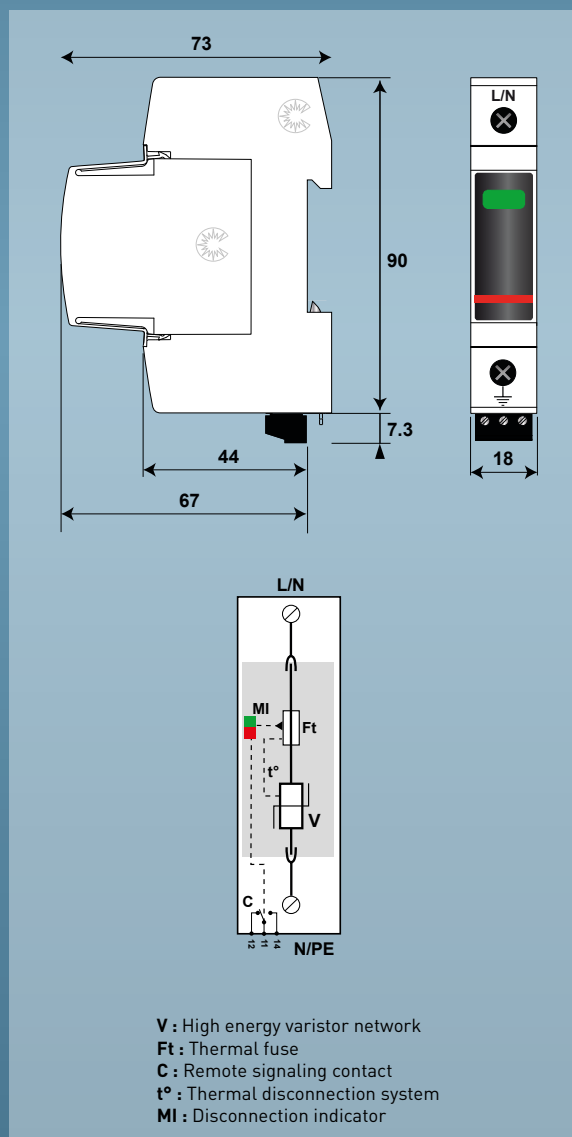

Characteristics

CITEL Model		DAC50-10-760	DAC50-10-440	DAC50-10-275	DAC50-10-150
Description		Type 2 AC surge protector - one-pole - pluggable			
Maximum AC operating voltage	Uc	760 Vac	440 Vac	275 Vac	150 Vac
Temporary Over Voltage (TOV) Characteristics - 5 sec.	UT	1000 Vac withstand	580 Vac withstand	335 Vac withstand	180 Vac withstand
Temporary Over Voltage (TOV) Characteristics - 120mn	UT	1325 Vac disconnection	770 Vac disconnection	440 Vac disconnection	230 Vac disconnection
Residual current - Leakage current at Uc	Ipe	< 1 mA	< 1 mA	< 1 mA	< 1 mA
Follow current	If	None	None	None	None
Nominal discharge current 15 x 8/20 μs impulses	In	20 kA	20 kA	20 kA	20 kA
Max. discharge current max. withstand @ 8/20 μs by pole	Imax	50 kA	50 kA	50 kA	50 kA
Protection level @ In (8/20 μs)	Up	2.9 kV	2 kV	1.25 kV	0.9 kV
Residual voltage @ 5 kA (8/20 μs)	Up-5kA	2.6 kV	1.5 kV	1 kV	0.6 kV
Admissible short-circuit current	Iscrc	50 000 A	50 000 A	50 000 A	50 000 A
Associated disconnectors					
Thermal disconnector		internal			
Fuses		50 A min. - 125 A max. - gG Type			
Installation ground fault breaker (if any)		Type "S" or delayed			
Mechanical characteristics					
Dimensions		see diagram - 1TE (EN43880)			
Connection to Network		By screw terminals: 2.5-25 mm ² (35mm ² rigid)			
Failsafe mode		Disconnection from network			
Disconnection indicator		1 mechanical indicator Green/Red			
Remote signaling of disconnection output on changeover contact		option DAC50S-10-760	option DAC50S-10-440	option DAC50S-10-275	option DAC50S-10-150
Max. voltage/current for remote signaling		250 V/0.5 A (AC) / 30V/2 A (DC)			
Wiring for remote signaling		max. 1.5 mm ²			
Mounting		Symmetrical rail 35 mm (EN60715)			
Operating temperature		-40/+85°C			
Protection rating		IP20			
Housing material		Thermoplastic UL94-V0			
Spare unit		MDAC50-760	MDAC50-440	MDAC50-275	MDAC50-150
Standards					
Certification		EN 61643-11 / IEC 61643-11			
Compliance		UL1449 ed.4			
Part number					
		821110711	821110411	821110211	821110111



CITEL

DAC50 Series

Type 2 AC Multipolar Surge Protector



DAC50S-xx-xxx

- Maximum operating voltage
- Configuration: 10 [1+0], 11 [1+1], 20 [2+0], 30 [3+0], 40 [4+0], 31 [3+1]
- «S» Remote signal option
- «50» Imax: 50 kA

Mechanical & Electrical diagrams

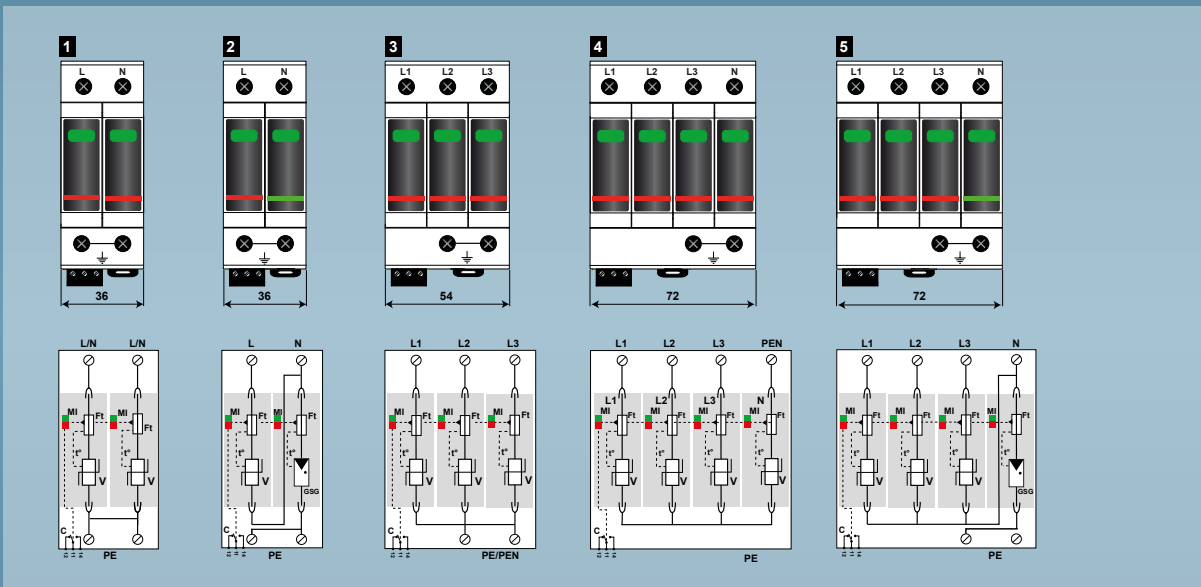

Characteristics

Model	Part number	Network	AC system	Protection Mode	Up L/PE	Up L/N	Up N/PE	Dimensions EN43880	Diagram
DAC50-31-275	821110234	230/400 V 3-phase+N	TT-TNS system [3+1]	L/N and N/PE	-	1.25 kV	1.5 kV	4 TE	5
DAC50-31-150	821110134	120/208 V 3-phase+N	TT-TNS system [3+1]	L/N and N/PE	-	0.9 kV	1.5 kV	4 TE	5
DAC50-40-440	821110414	230/400 V 3-phase+N	IT system [4+0]	L/PE and N/PE	2 kV	-	2 kV	4 TE	5
DAC50-40-275	821110214	230/400 V 3-phase+N	TNS system [4+0]	L/PE and N/PE	1.25 kV	-	1.25 kV	4 TE	4
DAC50-40-150	821110114	120/208 V 3-phase+N	TNS system [4+0]	L/PE and N/PE	0.9 kV	-	0.9 kV	4 TE	4
DAC50-30-440	821110413	230/400 V 3-phase	IT system [3+0]	L/PE	2 kV	-	-	3 TE	3
DAC50-30-275	821110213	230/400 V 3-phase	TNC system [3+0]	L/PE	1.25 kV	-	-	3 TE	3
DAC50-30-150	821110113	120/208 V 3-phase	TNC system [3+0]	L/PE	0.9 kV	-	-	3 TE	3
DAC50-11-275	821110232	230 V single phase	TT-TN system [1+1]	L/N and N/PE	-	1.25 kV	1.5 kV	2 TE	2
DAC50-11-150	821110132	120 V single phase	TT-TN system [1+1]	L/N and N/PE	-	0.9 kV	1.5 kV	2 TE	2
DAC50-20-440	821110412	230 V single phase	IT system [2+0]	L/PE and N/PE	2 kV	-	2 kV	2 TE	1
DAC50-20-275	821110212	230 V single phase	TN system [2+0]	L/PE and N/PE	1.25 kV	-	1.25 kV	2 TE	1
DAC50-20-150	821110112	120 V single phase	TN system [2+0]	L/PE and N/PE	0.9 kV	-	0.9 kV	2 TE	1

DACF25 Series

Type 2 AC surge protectors with integrated fuse

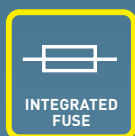

- Surge protectors with Integrated Fuse (SPDI)
- Not external fuse required
- In: 15 kA
- Imax: 25 kA
- Pluggable module for each phase
- Remote signaling (option)
- IEC 61643-11, EN 61643-11 certified
- UL1449 ed.4 compliance

Mechanical & Electrical diagrams

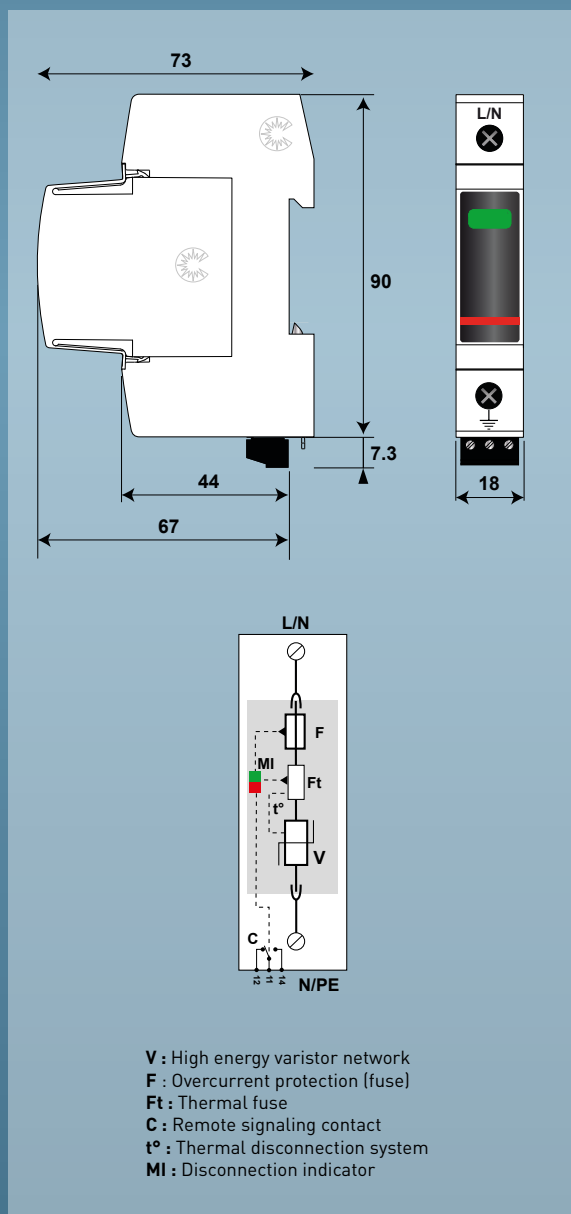

Characteristics

CITEL Model		DACF25-10-440	DACF25-10-320	DACF25-10-275	DACF25-10-150
Description		Type 2 AC surge protector with integrated fuse - one-pole - pluggable			
Max. AC operating voltage	Uc	440 Vac	320 Vac	275 Vac	150 Vac
Temporary Over Voltage (TOV) Characteristics - 5 sec.	UT	580 Vac withstand	335 Vac withstand	335 Vac withstand	180 Vac withstand
Temporary Over Voltage (TOV) Characteristics -120mn	UT	770 Vac disconnection	440 Vac disconnection	440 Vac disconnection	230 Vac disconnection
Residual current Leakage current at Uc	Ipe	< 1 mA	< 1 mA	< 1 mA	< 1 mA
Follow current	If	None	None	None	None
Nominal discharge current 15 x 8/20 μs impulses	In	15 kA	15 kA	15 kA	15 kA
Max. discharge current max. withstand @ 8/20 μs by pole	Imax	25 kA	25 kA	25 kA	25 kA
Protection level @ In (8/20μs)	Up	2 kV	1.5 kV	1.25 kV	0.9 kV
Residual voltage @ 5 kA (8/20μs)	Up-5kA	1.5 kV	1.2 kV	1 kV	0.6 kV
Admissible short-circuit current	Isc cr	100 000 A	100 000 A	100 000 A	100 000 A
Associated disconnectors					
Thermal disconnector		internal			
Fuses		internal (equivalent AC rating : 63 A, gG Type)			
Existing upstream ground fault breaker (if any)		Type "S" or delayed			
Mechanical characteristics					
Dimensions		see diagram, 1 TE (EN43880)			
Connection to Network		By screw terminals: 2.5-25 mm ² (35mm ² rigid)			
Failsafe mode		Disconnection from network			
Disconnection indicator		1 mechanical indicator Green/Red			
Remote signaling of disconnection output on changeover contact		option DACF25S-10-440	option DACF25S-10-320	option DACF25S-10-275	option DACF25S-10-150
Max. voltage/current for remote signaling		250 V/0.5 A (AC) / 30 V/2 A (DC)			
Wiring for remote signaling		max. 1.5 mm ²			
Mounting		Symmetrical rail 35 mm (EN60715)			
Operating temperature		-40/+85°C			
Protection rating		IP20			
Housing material		Thermoplastic UL94-V0			
Spare unit		MDACF25-440	MDACF25-320	MDACF25-275	MDACF25-150
Standards					
Certification		IEC 61643-11 / EN 61643-11			
Compliance		UL1449 ed.4			
Part number					
		821410411	821410311	821410211	821410111



CITEL

DACF25 Series

Type 2 AC Multipolar surge protectors with integrated fuse



DACF25S-xx-xxx

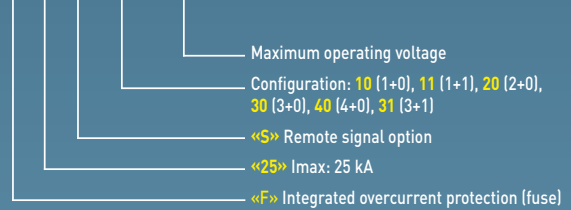

Mechanical & Electrical diagrams

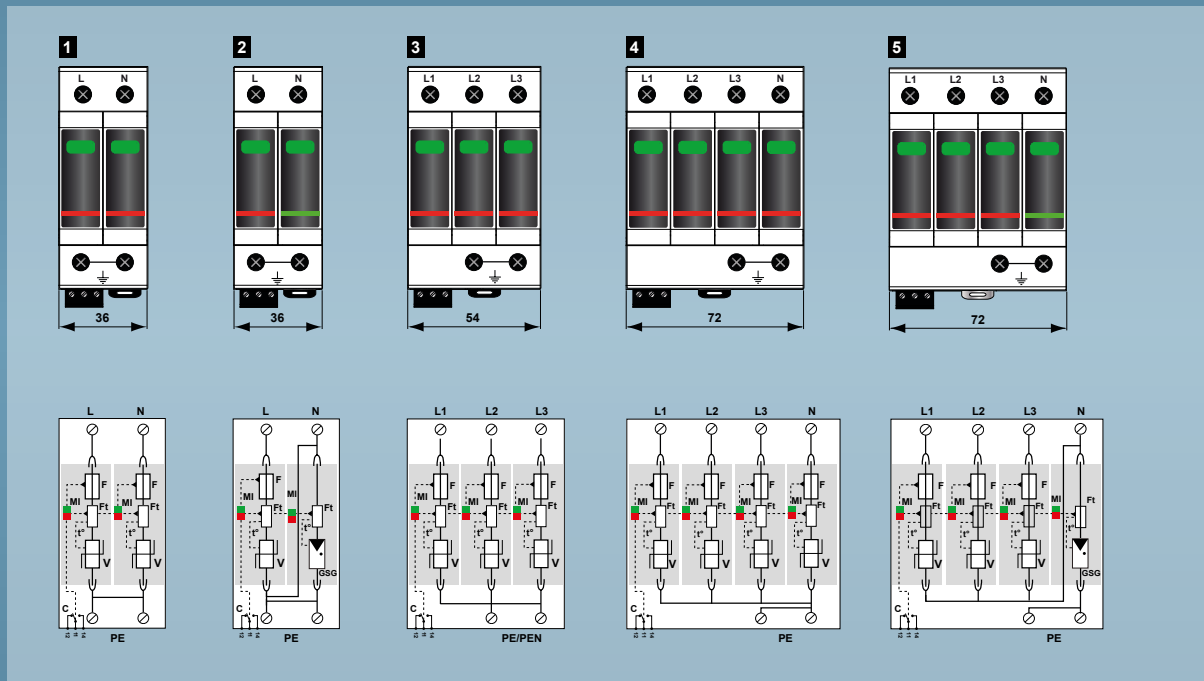

Characteristics

Model	P/N	Network	AC system	Protection mode	Up L/PE	Up L/N	Up N/PE	Dimension EN43880	Diagram
DACF25-31-320	821410334	230/400 V 3-Phase+N	TT-TNS System (3+1)	L/N and N/PE	-	1.5 kV	1.5 kV	4 TE	5
DACF25-31-275	821410234	230/400 V 3-Phase+N	TT-TNS System (3+1)	L/N and N/PE	-	1.25 kV	1.5 kV	4 TE	5
DACF25-31-150	821410134	120/208 V 3-Phase+N	TT-TNS System (3+1)	L/N and N/PE	-	0.9 kV	1.5 kV	4 TE	5
DACF25-40-440	821410414	230/400 V 3-Phase+N	IT System (4+0)	L/PE and N/PE	2 kV	-	2 kV	4 TE	4
DACF25-40-320	821410314	230/400 V 3-Phase+N	TNS System (4+0)	L/PE and N/PE	1.5 kV	-	1.5 kV	4 TE	4
DACF25-40-275	821410214	230/400 V 3-Phase+N	TNS System (4+0)	L/PE and N/PE	1.25 kV	-	1.25 kV	4 TE	4
DACF25-40-150	821410114	120/208 V 3-Phase+N	TNS System (4+0)	L/PE and N/PE	0.9 kV	-	0.9 kV	4 TE	4
DACF25-30-440	821410413	230/400 V 3-Phase	IT System (3+0)	L/PE	2 kV	-	-	3 TE	3
DACF25-30-320	821410313	230/400 V 3-Phase	TNC System (3+0)	L/PE	1.5 kV	-	-	3 TE	3
DACF25-30-275	821410213	230/400 V 3-Phase	TNC System (3+0)	L/PE	1.25 kV	-	-	3 TE	3
DACF25-30-150	821410113	120/208 V 3-Phase	TNC System (3+0)	L/PE	0.9 kV	-	-	3 TE	3
DACF25-11-320	821410332	230 V Single Phase	TT-TN System (1+1)	L/N and N/PE	-	1.5 kV	1.5 kV	2 TE	2
DACF25-11-275	821410232	230 V Single Phase	TT-TN System (1+1)	L/N and N/PE	-	1.25 kV	1.5 kV	2 TE	2
DACF25-11-150	821410132	120 V Single Phase	TT-TN System (1+1)	L/N and N/PE	-	0.9 kV	1.5 kV	2 TE	2
DACF25-20-440	821410412	230 V Single Phase	IT System (2+0)	L/PE and N/PE	2 kV	-	2 kV	2 TE	1
DACF25-20-320	821410312	230 V Single Phase	TN System (2+0)	L/PE and N/PE	1.5 kV	-	1.5 kV	2 TE	1
DACF25-20-275	821410212	230 V Single Phase	TN System (2+0)	L/PE and N/PE	1.25 kV	-	1.25 kV	2 TE	1
DACF25-20-150	821410112	120 V Single Phase	TN System (2+0)	L/PE and N/PE	0.9 kV	-	0.9 kV	2 TE	1



CITEL

DAC40C Series

Compact 1-phase Type 2 Surge Protector



DAC40CS-xx-xxx

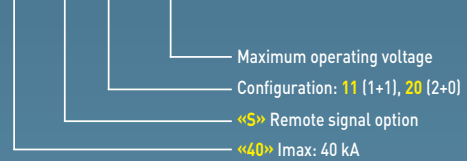

- Common/Differential mode
- Pluggable module
- IEC 61643-11, EN 61643-11, UL1449 ed.4 compliance

Mechanical & Electrical diagrams

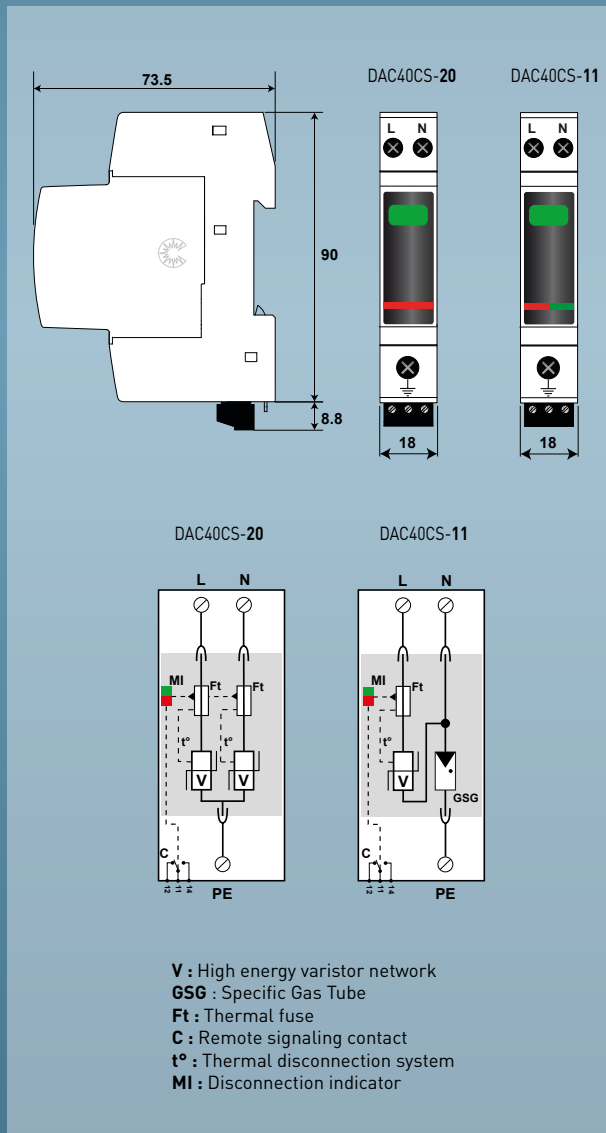

Characteristics

CITEL Model	DAC40C-20-440	DAC40C-11-275	DAC40C-11-150
Description	Compact 1-phase Type 2 surge protector - Pluggable		
Network	230 V single-phase		120 V single-phase
Connection mode	L/PE and N/PE	L/N and N/PE	L/N and N/PE
Max. AC operating voltage	Uc 440 Vac	275 Vac	150 Vac
Temporary Over Voltage (TOV)	580 Vac withstand	335 Vac withstand	180 Vac withstand
Characteristic - 5 sec.	UT		
Temporary Over Voltage (TOV)	770 Vac	440 Vac	230 Vac
Characteristic - 120mn	disconnection	disconnection	disconnection
Temporary Over Voltage N/PE (TOV HT)	UT	1200 V/300A/200 ms withstand	1200 V/300A/200 ms withstand
Residual current - Leakage current at Uc	Ipe < 1 mA	None	None
Follow current	If None	None	None
Nominal discharge current 15 x 8/20 μs impulses	In 20 kA	20 kA	20 kA
Max. discharge current max. withstand @ 8/20 μs by pole	I _{max} 40 kA	40 kA	40 kA
Total discharge current - @8/20μs	I _{total} 80 kA	40 kA	40 kA
Protection level @In (8/20μs)	Up L/N	1.25 kV	0.9 kV
	Up N/PE	1.8 kV	1.5 kV
	Up L/PE	1.8 kV	1.5 kV
Admissible short-circuit current	I _{sc} 10 000 A	10 000 A	10 000 A
Associated disconnectors			
Thermal disconnector	internal		
Fuses	50 A min. - 125 A max. - Type gG		
Existing upstream ground fault breaker (if any)	Type "S" or delayed		
Mechanical characteristics			
Dimensions	see diagram, 1TE (EN43880)		
Connection to Network	by screw terminals: L/n = 1.5-10mm ² (16 mm ²) / PE = 2.5-25mm ² (35 mm ² rigid)		
Failsafe mode	Disconnection from network		
Disconnection indicator	1 mechanical indicator Green/Red		
Remote signaling of disconnection output on changeover contact	Option DAC40CS-20-440	Option DAC40CS-11-275	Option DAC40CS-11-150
Max. voltage/current for remote signaling	250 V/0.5 A (AC) / 30 V/2 A (DC)		
Wiring for remote signaling	Max. 1.5 mm ²		
Mounting	Symmetrical rail 35 mm (EN60715)		
Operating temperature	-40/+85°C		
Protection rating	IP20		
Housing material	Thermoplastic UL94-V0		
Spare unit	MDAC40C-20-440	MDAC40C-11-275	MDAC40C-11-150
Standards			
Compliance	IEC 61643-11 / EN 61643-11 / UL1449 ed.4		
Part number			
	821510411	821520211	821520111



CITEL

DAC40C Series

Compact 3-phase Type 2 Surge Protector



DAC40CS-xx-xxx

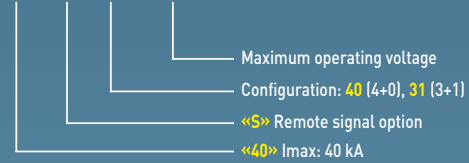

- Common/Differential mode
- Pluggable module
- IEC 61643-11, EN 61643-11, UL1449 ed.4 compliance

Mechanical & Electrical diagrams

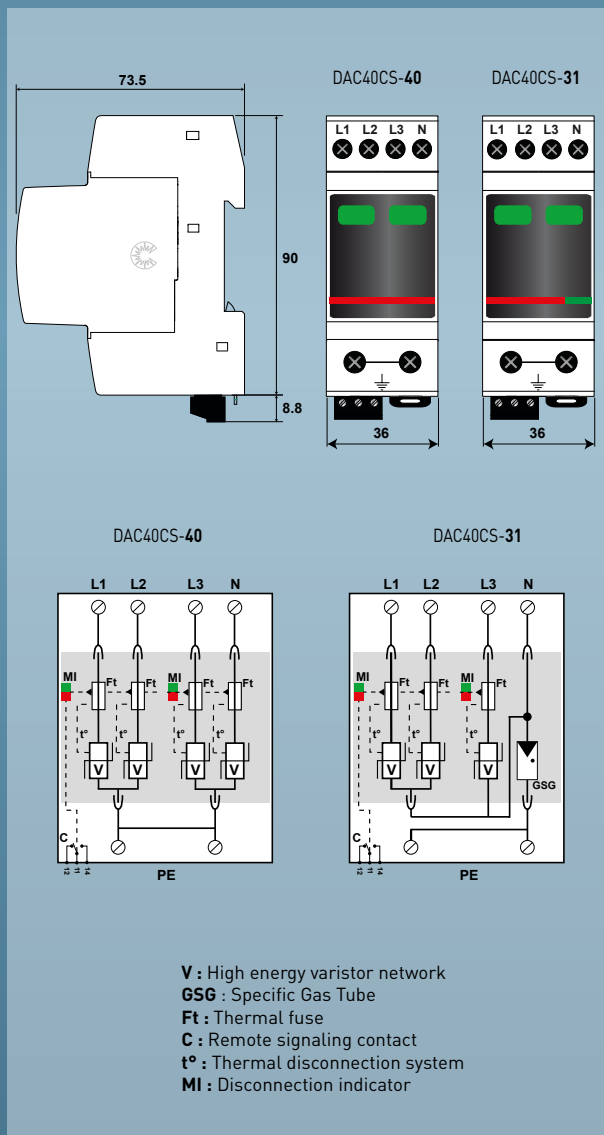

Characteristics

CITEL Model	DAC40C-40-440	DAC40C-31-275	DAC40C-31-150
Description	Compact 3-phase+N Type 2 surge protector - Pluggable		
Network	230/400 V 3-phase	230/400 V 3-phase	120/208 V 3-phase
Connection mode	L/PE and N/PE	L/N and N/PE	L/N and N/PE
Max. AC operating voltage	Uc 440 Vac	275 Vac	150 Vac
Temporary Over Voltage (TOV) Characteristic - 5 sec.	UT 580 Vac withstand	335 Vac withstand	180 Vac withstand
Temporary Over Voltage (TOV) Characteristic - 120mn	UT 770 Vac	440 Vac	230 Vac
Temporary Over Voltage N/PE (TOV HT)	UT -	1200 V/300A/200 ms withstand	1200 V/300A/200 ms withstand
Residual current - Leakage current at Uc	Ipe < 1 mA	None	None
Follow current	If None	None	None
Nominal discharge current 15 x 8/20 µs impulses	In 20 kA	20 kA	20 kA
Max. discharge current max. withstand @ 8/20 µs by pole	Imax 40 kA	40 kA	40 kA
Total discharge current @ 8/20 µs	Itotal 160 kA	40 kA	40 kA
Protection level @In (8/20 µs)	Up L/N - Up N/PE 1.8 kV Up L/PE 1.8 kV	1.25 kV 1.5 kV	0.9 kV 1.5 kV
Admissible short-circuit current	Iscrr 10000 A	10000 A	10000 A
Associated disconnectors			
Thermal disconnector	internal		
Fuses	50 A min. - 125 A max. - Type gG		
Existing upstream ground fault breaker (if any)	Type "S" or delayed		
Mechanical characteristics			
Dimensions	see diagram, 2 TE (EN43880)		
Connection to Network	by screw terminals: L/N = 1.5-10mm ² (16 mm ²) or PE = 2.5-25mm ² (35 mm ² rigid)		
Failsafe mode	Disconnection from network		
Disconnection indicator	2 mechanical indicators, Green/Red		
Remote signaling of disconnection output on changeover contact	Option DAC40CS-40-440	Option DAC40CS-31-275	Option DAC40CS-31-150
Max. voltage/current for remote signaling	250 V/0.5 A (AC) / 30 V/2 A (DC)		
Wiring for remote signaling	Max. 1.5 mm ²		
Mounting	Symmetrical rail 35 mm (EN60715)		
Operating temperature	-40/+85°C		
Protection rating	IP20		
Housing material	Thermoplastic UL94-V0		
Spare unit	MDAC40C-40-440	MDAC40C-31-275	MDAC40C-31-150
Standards			
Compliance	IEC 61643-11 / EN 61643-11 / UL1449 ed.4		
Part number			
	821510412	821520212	821520112

DAC15C Series

Compact 1-phase Type 2 (or 3) Surge Protector



DAC15CS-xx-xxx

- Maximum operating voltage
- Configuration: 11 [1+1], 20 [2+0]
- «S» Remote signal option
- «15» I_{max}: 15 kA

- Common/Differential mode
- Pluggable module
- IEC 61643-11, EN 61643-11, UL1449 ed.4 compliance

Mechanical & Electrical diagrams

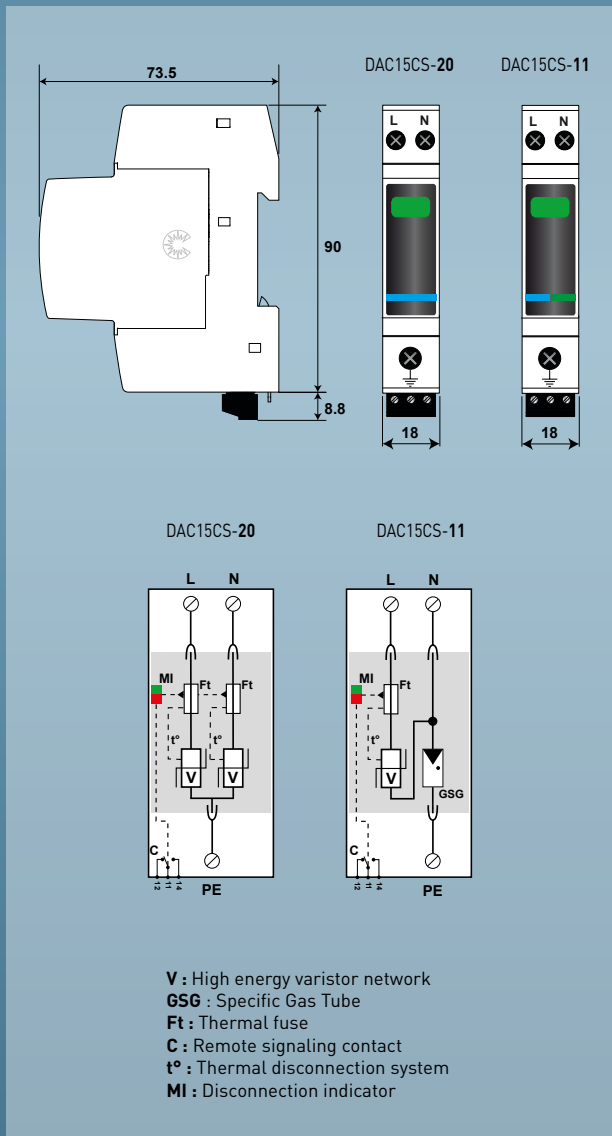

Characteristics

CITEL Model	DAC15C-20-440	DAC15C-11-275	DAC15C-11-150
Description	Compact 1-phase Type 2 surge protector - Pluggable		
Network	230/400 V single-phase	230/400 V single-phase	120/208 V single-phase
Connection mode	L/PE and N/PE	L/N and N/PE	L/N and N/PE
Max. AC operating voltage	U _c 440 Vac	275 Vac	150 Vac
Temporary Over Voltage (TOV) Characteristic 5 sec.	UT 580 Vac withstand	335 Vac withstand	180 Vac withstand
Temporary Over Voltage (TOV) Characteristic 120 mn	UT 770 Vac disconnection	440 Vac disconnection	230 Vac disconnection
Temporary Over Voltage N/PE (TOV HT)	UT -	1200 V/300A/200 ms withstand	1200 V/300A/200 ms withstand
Residual current - Leakage current at U _c	I _{pe} < 1 mA	None	None
Follow current	I _f None	None	None
Nominal discharge current 15 x 8/20 μs impulses	I _n 5 kA	5 kA	5 kA
Max. discharge current max. withstand @ 8/20 μs by pole	I _{max} 15 kA	15 kA	15 kA
Total discharge current @ 8/20 μs	I _{total} 30 kA	30 kA	30 kA
Withstand on combinaison waveform - Class III test	U _{oc} 10 kV	10 kV	10 kV
Protection level @ I _n (8/20 μs)	U _p L/N -	1 kV	0.6 kV
	U _p N/PE 1.3 kV	1.5 kV	1.5 kV
	U _p L/PE 1.3 kV	-	-
Admissible short-circuit current	I _{sc cr} 10000 A	10000 A	10000 A
Associated disconnectors			
Thermal disconnector	internal		
Fuses	20 A min - 125 A max. - Type gG		
Existing upstream ground fault breaker (if any)	Type "S" or delayed		
Mechanical characteristics			
Dimensions	see diagram, 1 TE (EN43880)		
Connection to Network	by screw terminals: L/N = 1.5-10 mm ² [16mm ²] or PE = 2.5-25 mm ² [35 mm ² rigid]		
Failsafe mode	Disconnection from network		
Disconnection indicator	1 mechanical indicators, Green/Red		
Remote signaling of disconnection output on changeover contact	Option DAC15CS-20-400	Option DAC15CS-11-275	Option DAC15CS-11-150
Max. voltage/current for remote signaling	250 V/0.5 A (AC) / 30 V/2 A (DC)		
Wiring for remote signaling	Max. 1.5 mm ²		
Mounting	Symmetrical rail 35 mm (EN60715)		
Operating temperature	-40/+85°C		
Protection rating	IP20		
Housing material	Thermoplastic UL94-V0		
Spare unit	MDAC15C-20-440	MDAC15C-11-275	MDAC15C-11-150
Standards			
Compliance	IEC 61643-11 / EN 61643-11 / UL1449 ed.4		
Part number			
	821610411	821620211	821620111

DAC15C Series

Compact 3-phase Type 2 (or 3) Surge Protector



DAC15CS-xx-xxx

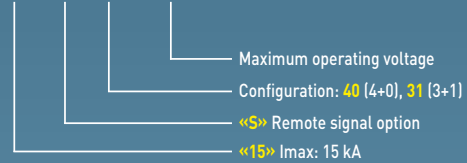

- Common/Differential mode
- Pluggable module
- IEC 61643-11, EN 61643-11 and UL1449 ed.4 compliance

Mechanical & Electrical diagrams

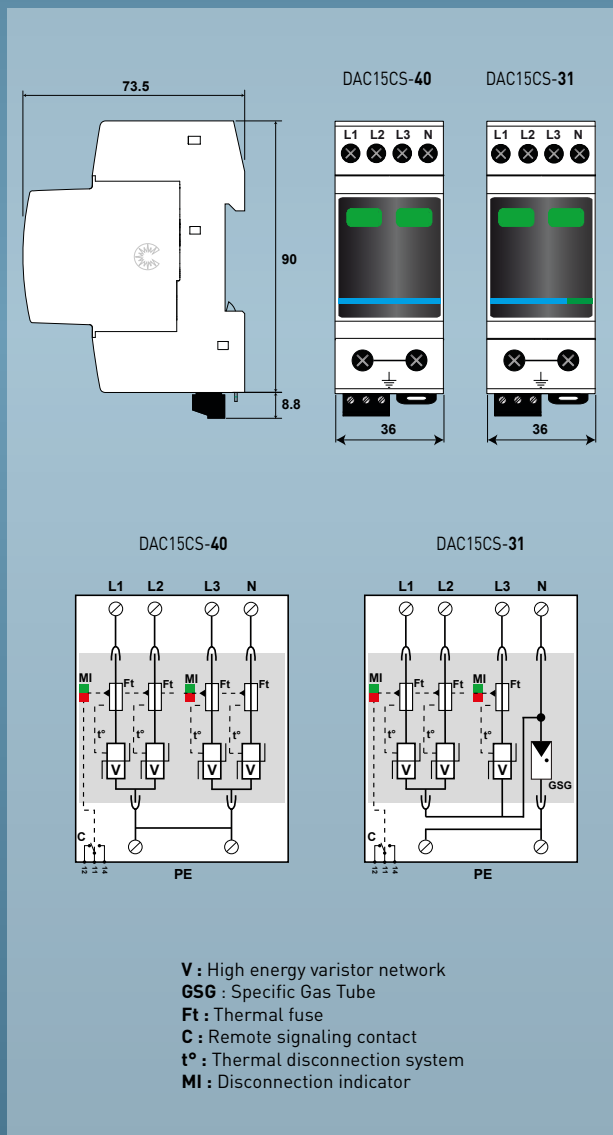

Characteristics

CITEL Model	DAC15C-40-440	DAC15C-31-275	DAC15C-31-150
Description	Compact 3-phase+N Type 2 surge protector - Pluggable		
Network	230/400 V 3-phase	230/400 V 3-phase	120/208 V 3-phase
Connection mode	L/PE and N/PE	L/N and N/PE	L/N and N/PE
Max. AC operating voltage	Uc 440 Vac	275 Vac	150 Vac
Temporary Over Voltage (TOV)	580 Vac withstand	335 Vac withstand	180 Vac withstand
Characteristic - 5 sec.	UT	UT	UT
Temporary Over Voltage (TOV) Characteristic - 120 mn	770 Vac disconnection	440 Vac disconnection	230 Vac disconnection
Temporary Over Voltage N/PE (TOV HT)	UT	1200 V/300A/200 ms withstand	1200 V/300A/200 ms withstand
Residual current - Leakage current at Uc	Ipe < 1 mA	None	None
Follow current	If None	None	None
Nominal discharge current 15 x 8/20 µs impulses	In 5 kA	5 kA	5 kA
Max. discharge current max. withstand @ 8/20 µs by pole	Imax 15 kA	15 kA	15 kA
Total discharge current - @ 8/20 µs	Itotal 60 kA	40 kA	40 kA
Withstand on combination waveform - Class III test	Uoc 10 kV	10 kV	10 kV
Protection level @ In (8/20µs)	Up L/N -	0.9 kV	0.6 kV
	Up N/PE 1.3 kV	1.5 kV	1.5 kV
	Up L/PE 1.3 kV	-	-
Admissible short-circuit current	Iscrr 10000 A	10000 A	10000 A
Associated disconnectors			
Thermal disconnector	internal		
Fuses	20 A min. - 125 A max. - Type gG		
Existing upstream ground fault breaker (if any)	Type "S" or delayed		
Mechanical characteristics			
Dimensions	see diagram, 2 TE (EN43880)		
Connection to Network	by screw terminals: L/N: 1.5-10mm ² (16mm ²) or PE: 2.5-25mm ² (35mm ² rigid)		
Failsafe mode	Disconnection from network		
Disconnection indicator	2 mechanical indicators, Green/Red		
Remote signaling of disconnection output on changeover contact	Option DAC15CS-40-400	Option DAC15CS-31-275	Option DAC15CS-31-150
Max. voltage/current for remote signaling	250 V/0.5 A (AC) / 30 V/2 A (DC)		
Wiring for remote signaling	Max. 1.5 mm ²		
Mounting	Symmetrical rail 35 mm (EN60715)		
Operating temperature	-40/+85°C		
Protection rating	IP20		
Housing material	Thermoplastic UL94-V0		
Spare unit	MDAC15C-40-440	MDAC15C-31-275	MDAC15C-31-150
Standards			
Compliance	IEC 61643-11 / EN 61643-11 / UL1449 ed.4		
Part number			
	821610412	821620212	821620112

DC Power Surge Protectors



Type 1 and Type 2 DDC series

- Type 1+2 or Type 2 pluggable surge protectors designed for equipment connected to DC powerlines.
- One or Two-pole unit
- Technology based on high energy varistor equipped with thermal disconnection mechanism.
- Remote disconnection signaling feature (option)
- prIEC61643-41 compliance (forthcoming standard for DC power SPD)



Type 2 compact DDxxCC series

- Type 2 pluggable surge protectors designed for equipment connected to DC powerlines.
- Compact design to fit inside small cabinets
- Remote disconnection signaling feature (option)
- prIEC61643-41 compliance (forthcoming standard for DC power SPD)
- Available for DC powerline from 12 to 350 Vdc.



DDC Series

Type 1 and Type 2 DC power Surge Protectors



DDC30S-x0-xx

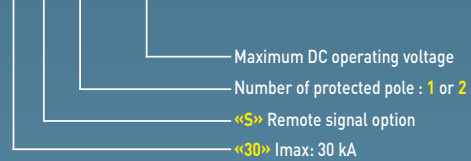

- For 48 Vdc and 75 Vdc
- Pluggable module
- Remote signaling (option)
- prIEC 61643-41 compliance

Mechanical & Electrical diagrams

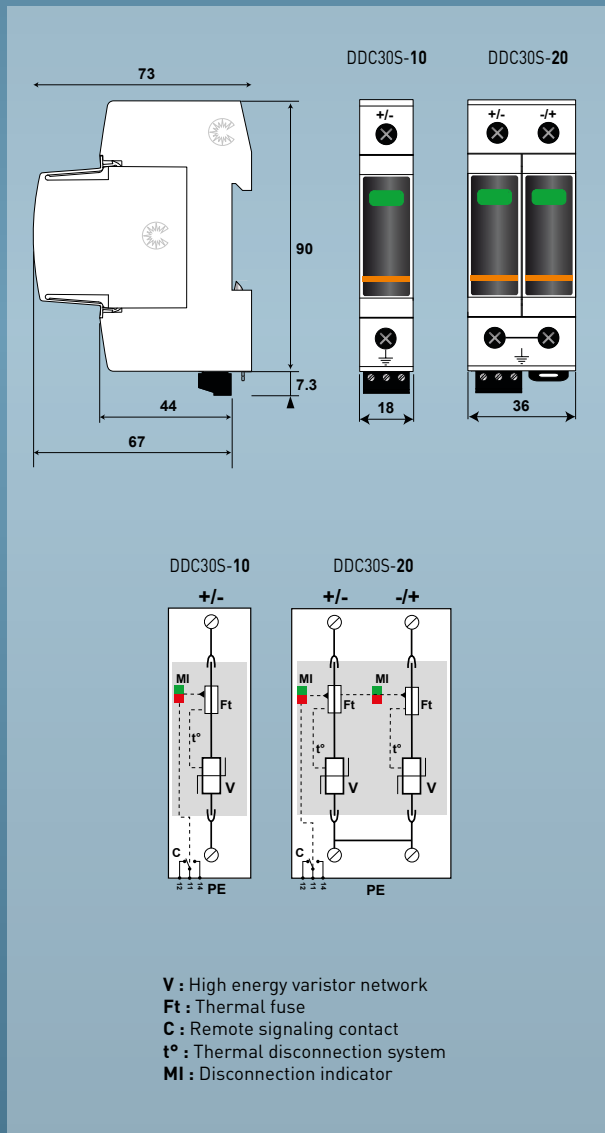

Characteristics

CITEL Model	DDC30-10-65	DDC30-10-85	DDC30-20-65	DDC30-20-85	
Description	1-pole DC surge protector	2-pole DC surge protector			
Nominal DC voltage	Un	48 Vdc	75 Vdc	48 Vdc	75 Vdc
Connection mode	+/- and -/PE	+/-PE and -/PE	+/-PE and -/PE	+/-PE and -/PE	
Max. DC operating voltage	Uc-DC	65 Vdc	85 Vdc	65 Vdc	85 Vdc
Max. AC operating voltage	Uc-AC	50 Vac	60 Vac	50 Vac	60 Vac
Residual current <i>Leakage current at Uc</i>	Ipe	< 0.1 mA	< 0.1 mA	< 0.1 mA	< 0.1 mA
Follow current	If	None	None	None	None
Nominal discharge current <i>15 x 8/20 μs impulses</i>	In	15 kA	15 kA	15 kA	15 kA
Max. discharge current <i>max. withstand @ 8/20 μs by pole</i>	Imax	30 kA	30 kA	30 kA	30 kA
Total discharge current <i>@ 8/20 μs</i>	Imax total	60 kA	60 kA	60 kA	60 kA
Max. lightning current by pole <i>max. withstand @ 10/350 μs</i>	Iimp	4 kA	4 kA	4 kA	4 kA
Protection level <i>@ In (8/20 μs) +/-PE [-PE]</i>	Up	300 V	390 V	300 V	390 V
	Up	-	600 V	780 V	780 V
Admissible short circuit current	Iscrr	50 000 A	50 000 A	50 000 A	50 000 A
Associated disconnectors					
Thermal disconnector	internal				
Fuses (if requested)	50 A min. - 125 A max. - Fuses type gG				
Mechanical characteristics					
Dimensions	see diagram - 1 TE (EN43880)		see diagram - 2 TE (EN43880)		
Connection to Network	Screw terminals: 2.5-25 mm ² +/- : 1.5-10 mm ²				
Failsafe mode	Disconnection from network				
Disconnection indicator	1 mechanical indicator Green/Red		2 mechanical indicators, Green/Red		
Remote signaling of disconnection output on changeover contact	option DDC30S-10-65	option DDC30S-10-85	option DDC30S-20-65	option DDC30S-20-85	
Max. voltage/current for remote signaling	250 V/0.5 A (AC) / 30 V/2 A (DC)				
Wiring for remote signaling	Max. 1.5 mm ²				
Mounting	Symmetrical rail 35 mm (EN60715)				
Operating temperature	-40/+85°C				
Protection rating	IP20				
Housing material	Thermoplastic UL94-V0				
Spare unit	MDDC30-65	MDDC30-85	MDDC30-65	MDDC30-85	
Standards					
Compliance	prIEC 61643-41				
Part number					

DDCC Series

Type 2 Compact DC power Surge Protectors



- Type 2 DC power surge protectors
- From 12 to 350 Vdc DC network
- I_{max}: 20, 30 and 40 kA
- Compact Design
- Pluggable module
- Remote signaling option
- prIEC 61643-41 compliance
- IEC 61643-31 compliance

Mechanical & Electrical diagrams

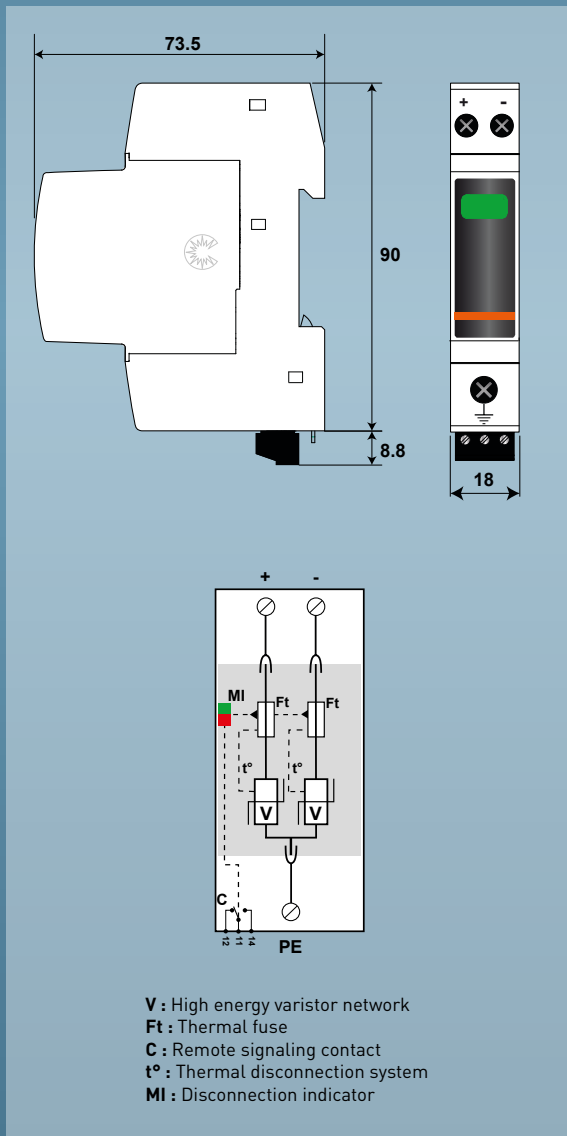

Characteristics

CITEL Model	DDC20C-20-24	DDC20C-20-38	DDC30C-20-65
Network	12Vdc	24Vdc	48 Vdc
Connection mode	+/-/PE	+/-/PE	+/-/PE
Max. DC operating voltage	Uc 24 Vdc	38 Vdc	65 Vdc
Max. AC operating voltage	Uc 20 Vac	30 Vac	50 Vac
Nominal voltage PV-DC	Uocstc 12 Vdc	24 Vdc	48 Vdc
Max. operating voltage PV-DC	Ucpv 24 Vdc	38 Vdc	65 Vdc
Permanent operating current @ Ucpv	Icpv < 0.1 mA	< 0.1 mA	< 0.1 mA
Residual current Leakage current at Uc	Ipe < 0.1 mA	< 0.1 mA	< 0.1 mA
Follow current	If None	None	None
Nominal discharge current 15 x 8/20 μs impulses	In 10 kA	10 kA	15 kA
Max. discharge current max. withstand @ 8/20 μs by pole	I _{max} 20 kA	20 kA	30 kA
Total discharge current @ 8/20 μs	I _{total} 40 kA	40 kA	60 kA
Protection level @ In +/-PE (-/PE)	Up 250 V	250 V	300 V
Admissible short circuit current	I _{sc} 10 000 A	10 000 A	10 000 A
Current withstand short circuit PV	I _{scpv} 1000 A	1000 A	1000 A
Associated disconnectors			
Thermal disconnector	internal		
Fuses (if required)	20 A min - 125 A max - Type gG		50 A min. - 125 A max. - Type gG
Mechanical characteristics			
Dimensions	see diagram, 1 TE (EN43880)		
Connection to Network	by screw terminals: 1.5-10mm ² (actives wires) and 2.5-25mm ² (ground)		
Disconnection indicator	1 mechanical indicator, Green/Red		
Failure mode	Disconnection from network		
Remote signaling of disconnection output on changeover contact	Option DDC20CS-20-24	Option DDC20CS-20-38	Option DDC30CS-20-65
Max. voltage/current for remote signaling	250 V/0.5 A (AC) / 30 V/2 A (DC)		
Wiring for remote signaling	Max. 1.5 mm ²		
Mounting	Symmetrical rail 35 mm (EN60715)		
Operating temperature	-40/+85°C		
Protection rating	IP20		
Housing material	Thermoplastic UL94-V0		
Spare unit	MDDC20C-20-24	MDDC20C-20-38	MDDC30C-20-65
Standards			
Compliance	IEC 61643-11 / EN 61643-11 / UL1449 ed.4		
Part number			
	-	-	-



DDCxxCS-20-xx

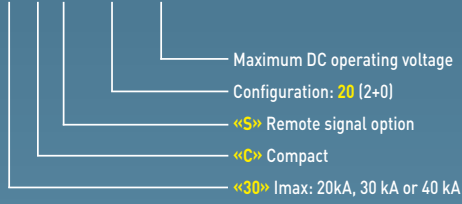

DDC40C-20-100	DDC40C-20-125	DDC40C-20-150	DDC40C-20-180	DDC40C-20-275	DDC40C-20-350	DDC40C-20-460
75 Vdc	95 Vdc	110 Vdc	130 Vdc	220 Vdc	280 Vdc	350 Vdc
+/-/PE	+/-/PE	+/-/PE	+/-/PE	+/-/PE	+/-/PE	+/-/PE
100 Vdc	125 Vdc	150 Vdc	180 Vdc	275 Vdc	350 Vdc	460 Vdc
75 Vac	95 Vac	115 Vac	150 Vac	210 Vac	275 Vac	350 Vac
75 Vdc	95 Vdc	110 Vdc	130 Vdc	220 Vdc	280 Vdc	350 Vdc
100 Vdc	125 Vdc	150 Vdc	180 Vdc	275 Vdc	350 Vdc	460 Vdc
< 0.1 mA	< 0.1 mA	< 0.1 mA	< 0.1 mA	< 0.1 mA	< 0.1 mA	< 0.1 mA
< 0.1 mA	< 0.1 mA	< 0.1 mA	< 0.1 mA	< 0.1 mA	< 0.1 mA	< 0.1 mA
None	None	None	None	None	None	None
20 kA	20 kA	20 kA	20 kA	20 kA	20 kA	20 kA
40 kA	40 kA	40 kA	40 kA	40 kA	40 kA	40 kA
80 kA	80 kA	80 kA	80 kA	80 kA	80 kA	80 kA
390 V	450 V	500 V	620 V	900 V	1200 V	1400 V
10 000 A	10 000 A	10 000 A	10 000 A	10 000 A	10 000 A	10 000 A
1000 A	1000 A	1000 A	1000 A	1000 A	1000 A	1000 A
50 A min. - 125 A max. - Type g6						
Option DDC40CS-20-100	Option DDC40CS-20-125	Option DDC40CS-20-150	Option DDC40CS-20-180	Option DDC40CS-20-275	Option DDC40CS-20-350	Option DDC40CS-20-460
MDDC40C-20-100	MDDC40C-20-125	MDDC40C-20-150	MDDC40C-20-180	MDDC40C-20-275	MDDC40C-20-350	MDDC40C-20-460
-	-	-	-	-	-	-

SELECTION OF SPD FOR

Following
IEC 60364-4-443 and
IEC 60364-5-534



LPL I or II

LPL III or IV

OR



Reinforced

Standard

Selection of SPDs in re

Installation in the main distribution panel (3-Phase)

DS254VG-300/G



- 3-Phase + N
- TN or TT systems
- Type 1+2+3
- Iimp 25 kA/pole
- VG-Technology

DS2



DAC1-13VGS-31-275



- 3-Phase + N
- TN or TT systems
- Type 1+2+3
- Iimp 12.5 kA/pole
- VG-Technology
- Pluggable

DAC1



DAC50VGS-31-275



- 3-Phase + N
- TN or TT systems
- Type 2+3
- I_{max} 50 kA
- VG-Technology
- Pluggable

DAC50S-31-275



- 3-Phase + N
- TN or TT systems
- Type 2
- I_{max} 50 kA
- Pluggable

DAC



DAC40CS-31-275



- Compact SPD
- 3-Phase + N
- TN or TT systems
- Type 2
- I_{max} 40 kA
- Pluggable

*** DAC4**



AC POWERLINE

relation with their location and the international standard

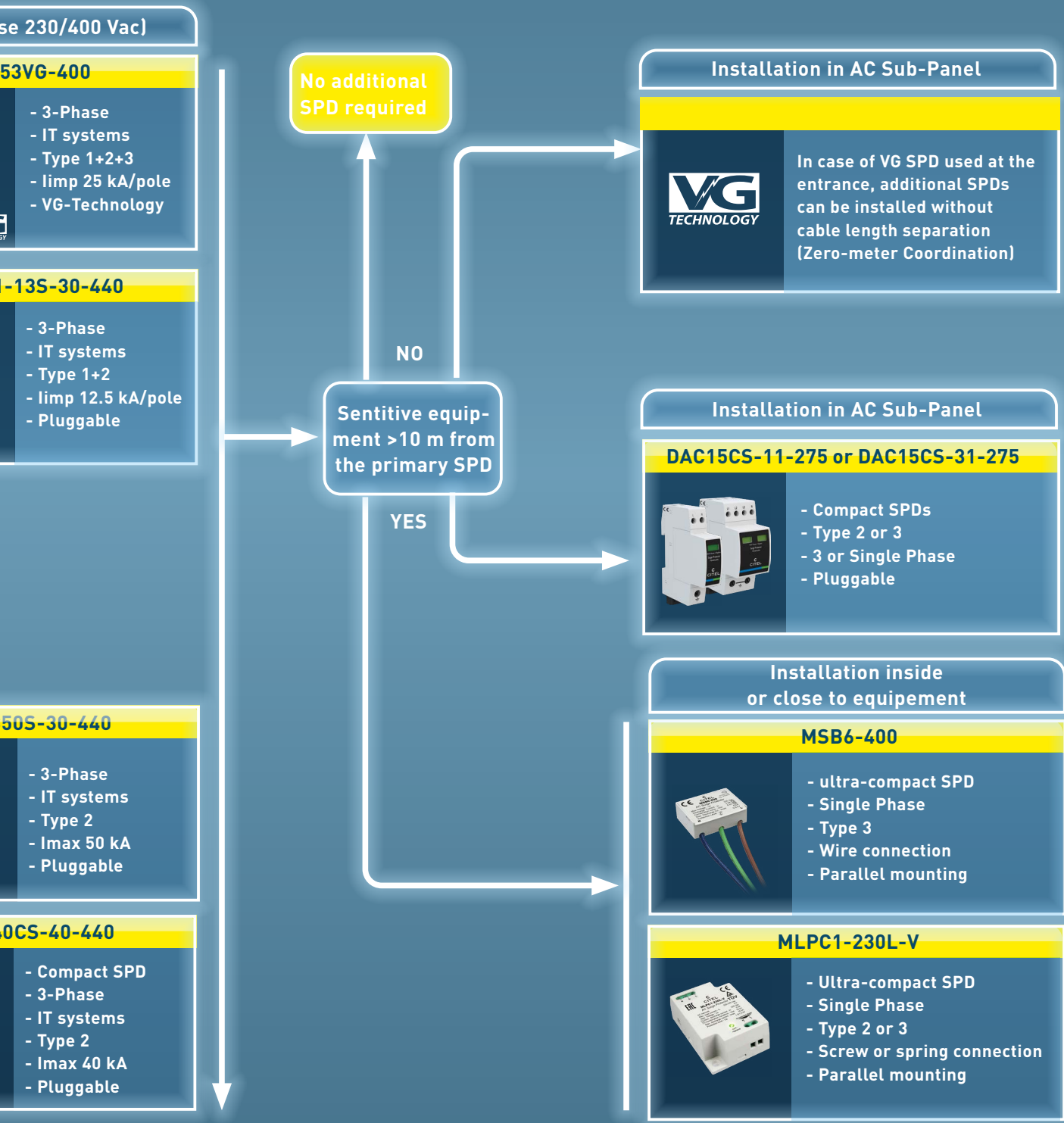



CITEL



France

Head Office

Sèvres
Tel. : +33 1 41 23 50 23
e-mail : contact@citel.fr
Web : www.citel.fr

Factory

Reims
Tel. : +33 3 26 85 74 00
e-mail : contact@citel.fr

Germany

Bochum
Tel. : +49 234 54 72 10
e-mail : info@citel.de
Web : www.citel.de

USA

Miramar
Tel : (954) 430 6310
e-mail : info@citel.us
Web site : www.citel.us

P.R China

Sales department

Shanghai
Tel. : +86 21 58 12 25 25
e-mail : info@citelsh.com
Web : www.citel.cn

Factory

Tel. : +86 21 58 12 80 67

Russia

Moscou
Tel. : +7 499 391 47 64
e-mail : info@citel.ru
Web : www.citel.ru

India

New Delhi
Tel. : +91 11 2626 12 38
e-mail : indiacitel@gmail.com
Web : www.citel.in

Thailand

Bangkok
Tel. : +66 (0) 2 104 9214
Web : www.citel.fr



CITEL