

SunWize Enclosures



SunWize
Age of Power Autonomy



SunWize Power & Battery is a small business enterprise that designs and builds reliable, stand-alone industrial metal products, solar modules, system solutions and electronic assemblies for integration into OEM products and off-grid field applications. With 25 years of proven reliability in extreme environments, our product lines are trusted by leading governments, fortune 500 companies, and small businesses alike.

Our enclosures are one of our best selling and most well-known products, and for good reason. Every SunWize enclosure is Aluminum, designed to NEMA3R outdoor rating and features Made in America manufacturing. Every enclosure features one or more backplates for mounting system control panels and customer equipment in addition to having room for various battery quantities, depending on the exact enclosure model.



**Trusted designs
with thousands of
units installed on
all 7 continents!**



www.sunwize.com/shop

Table of Contents

Pages 3-7: F-Series Enclosures
 Pages 8-10: WF-Series Enclosures
 Pages 11-15: M-Series Enclosures
 Pages 16-19: C-Series Enclosures
 Pages 20: E-Series Enclosures
 Pages 21-24: T-Series Enclosures
 Pages 25: UPS Enclosure
 Pages 26-31: Accessories
 Pages 32-34: Control Panels



Series	Powder Coated	Pole Mounted	Ground Mounted	2nd Control Panel	Pad-Lock Hasp	Keyed Latch	Pad-Lock Latch
F	X	O	O	O		X	O
WF	X	O	O			X	O
M	X	X	O	O		O	X
C		O	O		X		
E		X			X		
T	X		X	O	X		
UPS	X		X	O		X	O

X - Standard Feature

O - Optional Feature

Economy Battery Enclosures: F Series

Cost-effective solutions for housing one to four batteries (up to group size 31) with supporting equipment. NEMA3R rated, white power-coated or mill-finished aluminum enclosures feature hinged, key-lockable doors with dust covers on locks and gasketed door. Passive cooling ventilation. Two rear ½" electrical knock-outs. All Power Ready Express (PRE) Control Panels fit in F-Series enclosures.

SWPB Part #	Model	Finish	Maximum Quantity x Battery Group	Locking Feature	H x W x D (inches)	Weight (lbs.)
004154	F1	Powder-coated	1 x G31	Keyed latch	20.8 x 16.0 x 9.4	25
004219	F2	Powder-coated	2 x G31	Keyed latch	20.8 x 16.0 x 14.4	30
004222	F4	Powder-coated	4 x G31	Keyed latch	32.0 x 16.0 x 14.4	40
260003	F4-Tall	Powder-Coated	4 x G31	Keyed Latch	46.0 x 16.0 x 15.75	45

(F Series Bracket Accessory Options - Sold Separately)

SWPB Part#	Model	Finish	Description	H x W x D (inches)	Weight (lbs.)
004386	F-BKTSET	Power-coated	Pole Mounting Bracket	2 x 2 x 13	2.0
004373	PD-MTGBKTSET	Mill-finished	Pad Mounting Bracket	1.6 x 1.6 x 20	4.0

Optional F-Series Power Electronics Mounting Panels

SWPB Part#	Model	Description	Dimensions H x W (inches)	Weight (lbs.)
004228	F-HC-RP-B	Rear panel-blank	15.0 x 6.5	1.0
004237	F-HC-RP-D	Rear panel-drilled	15.0 x 6.5	1.0
007871	F-HC-RSP-1B	Right side-blank	8.75 x 3.75	0.5
007872	F-HC-RSP-2/4B	Right side-blank	9.5 x 6.25	0.5
250004	F-HC-RP-TF4	Rear panel-blank	15.4 x 13.25	2.0
240015	Radio Shelf	Radio Shelf	15.0 x 7.5	1.0



Room for electronics backplate and between 1 to 4 Group 31 batteries



Padmount & Pole-mount Options Available



SHOP NOW



Headquarters
30893 Ehlen Dr Sw
Albany, OR 97321
(866) 827-6527



F1 Aluminum Enclosure **004154**



F1 Enclosure with a single G31 battery

The SunWize Power & Battery F1 aluminum enclosure features a white powder-coated finish and a NEMA3R rating for indoor or outdoor use. The F1 enclosure can mount on a flat vertical surface or on a variety of pole sizes. It also features hinged, key-lockable doors with dust covers on locks and gasketed door. Passive cooling ventilation.

The F1 enclosure can hold a variety of battery sizes with plenty of space left over for controls equipment on its backplate. The rear mounted backplate measures 15" x 6.5" and the side mounted backplate measures 8.75" x 3.75". There are three 1/2" knockouts available on the back for wiring purposes.

Physical Dimensions **20.8"H x 16.0"W x 9.4"D** **25lbs**

FEATURES:

- NEMA3R Aluminum Enclosure
- Three 1/2" Knockouts
- Key-lockable door
- Pole or surface mounted
- Works with [240015](#) Radio Shelf or [007871](#) Side Plate, not both

F1 enclosure battery quantities

Group Size / BCI No.	Dimensions (L x W x H) inches	Quantity
U1	7.71" x 5.18" x 6.89"	3
40	7.76" x 6.62" x 6.87"	3
22NF	9.01" x 5.43" x 9.00"	2
34	10.00" x 6.88" x 7.63"	2
24	11.13" x 6.60" x 9.25"	1
27	12.00" x 6.63" x 9.06"	1
31	12.9" x 6.75" x 9.27"	1

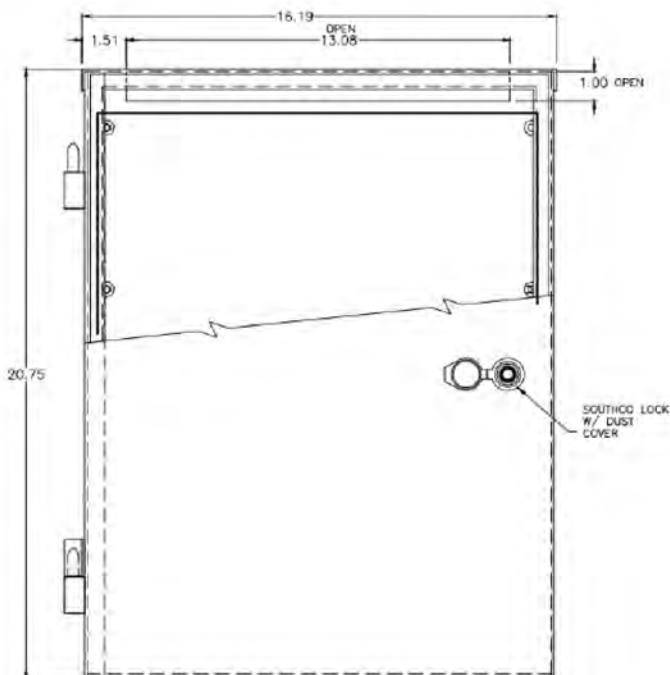

F2 Aluminum Enclosure **004219**



F2 Enclosure with two G31 batteries

The SunWize Power & Battery F2 aluminum enclosure features a white powder-coated finish and a NEMA3R rating for indoor or outdoor use. The F2 enclosure can mount on a flat vertical surface or on a variety of pole sizes. It also features hinged, key-lockable doors with dust covers on locks and gasketed door. Passive cooling ventilation.

The F2 enclosure can hold a variety of battery sizes with plenty of space left over for controls equipment on its backplate. The rear mounted backplate measures 15" x 6.5" and the side mounted backplate measures 9.5" x 6.25". There are three 1/2" knockouts available on the back for wiring purposes.

Physical Dimensions **20.8"H x 16.0"W x 14.4"D** **30lbs**

FEATURES:

- NEMA3R Aluminum Enclosure
- Three 1/2" Knockouts
- Key-lockable door
- Pole or surface mounted
- Works with [240015](#) Radio Shelf or [007872](#) Side Plate, not both

F2 enclosure battery quantities

Group Size / BCI No.	Dimensions (L x W x H) inches	Quantity
U1	7.71" x 5.18" x 6.89"	4
40	7.76" x 6.62" x 6.87"	4
22NF	9.01" x 5.43" x 9.00"	4
34	10.00" x 6.88" x 7.63"	2
24	11.13" x 6.60" x 9.25"	2
27	12.00" x 6.63" x 9.06"	2
31	12.9" x 6.75" x 9.27"	2

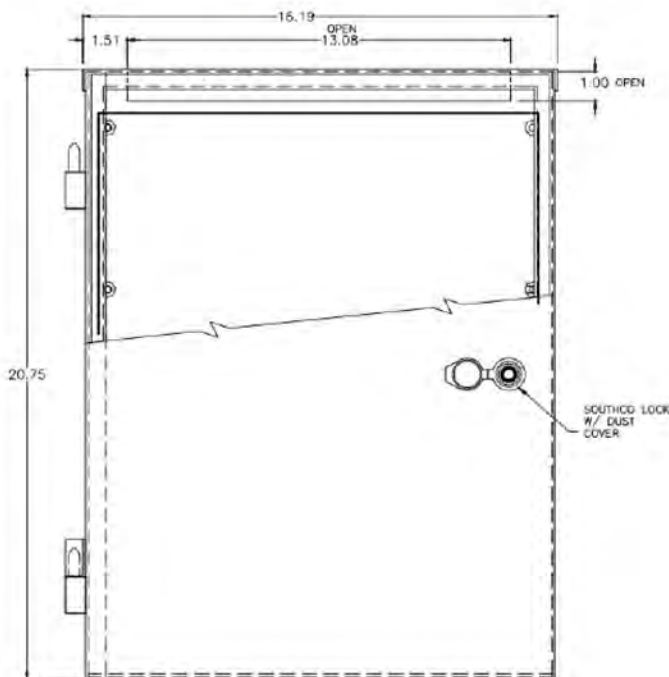

F4 Aluminum Enclosure

004222

F4 Enclosure with four G31 batteries



The SunWize Power & Battery F4 aluminum enclosure features a white powder-coated finish and a NEMA3R rating for indoor or outdoor use. The F4 enclosure can mount on a flat vertical surface or on a variety of pole sizes. It also features hinged, key-lockable doors with dust covers on locks and gasketed door. Passive cooling ventilation.

The F4 enclosure can hold a variety of battery sizes with plenty of space left over for controls equipment on its backplate. The rear mounted backplate measures 15" x 6.5" and the side mounted backplate measures 9.5" x 6.25". There are three 1/2" knockouts available on the back for wiring purposes.

32"H x 16.0"W x 14.4"D

40lbs

F4 enclosure battery quantities

Group Size / BCI No.	Dimensions (L x W x H) inches	Quantity
24	11.13" x 6.60" x 9.25"	4
27	12.00" x 6.63" x 9.06"	4
31	12.9" x 6.75" x 9.27"	4
GC2	10.38" x 7.13" x 10.88"	2

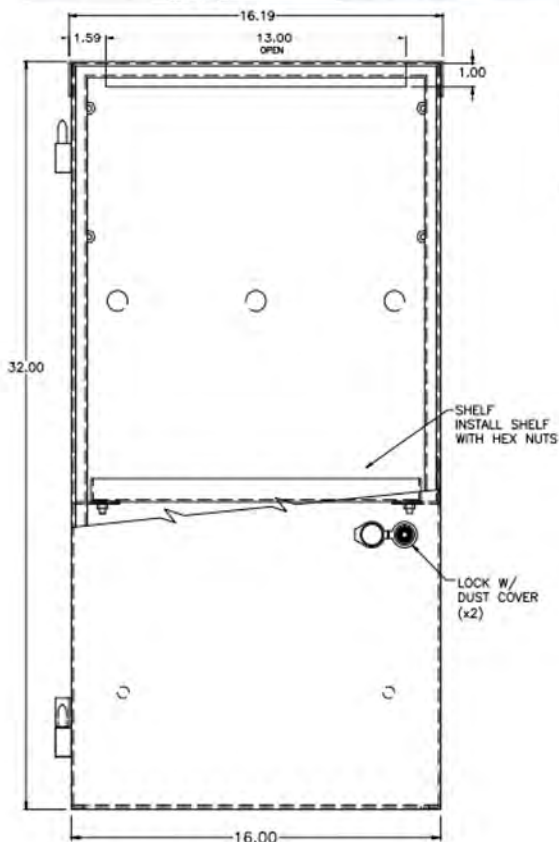

FEATURES:

- NEMA3R Aluminum
- Three 1/2" Knockouts
- Key-lockable door
- Pole or surface mounted
- Works with [240015](#) Radio Shelf or [007872](#) Side Plate, not both
- Removable Battery Shelf

F4-Tall Aluminum Enclosure **260003**

F4-Tall Enclosure will fit four "Oversized" Group 31 batteries, unlike our F4, while simultaneously having more space for control panel items



The SunWize Power & Battery F4-Tall aluminum enclosure features a white powder-coated finish and a NEMA3R rating for indoor or outdoor use. The F4-Tall enclosure can mount on a flat vertical surface or on a variety of pole sizes. It also features feature hinged, key-lockable doors with dust covers on locks and gasketed door. Passive cooling ventilation.

The F4-Tall enclosure can hold a variety of battery sizes with plenty of space left over for controls equipment on its backplate. The rear mounted backplate measures 15.375" x 13.25" and the side mounted backplate measures 9.5" x 13.25". There are three 1/2" knockouts available on the back for wiring purposes.

47"H x 16.0"W x 15.75"D / **45lbs**

F4-Tall enclosure battery quantities

Group Size / BCI No.	Dimensions (L x W x H) inches	Quantity
24	11.13" x 6.60" x 9.25"	4
27	12.00" x 6.63" x 9.06"	4
31	12.9" x 6.75" x 9.27"	4
Oversized 31	13.39" x 6.81" x 11.10"	4
GC2	10.38" x 7.13" x 10.88"	2

FEATURES:

- NEMA3R Aluminum Enclosure
- Three 1/2" Knockouts
- Key-lockable door
- Pole or surface mounted
- Uses [250004](#) backplate 15.4" x 13.25" for extra space compard to F4
- Works with modified Radio Shelf or [250005](#) Side Plate, not both
- Fits Oversized G31 Battery Style

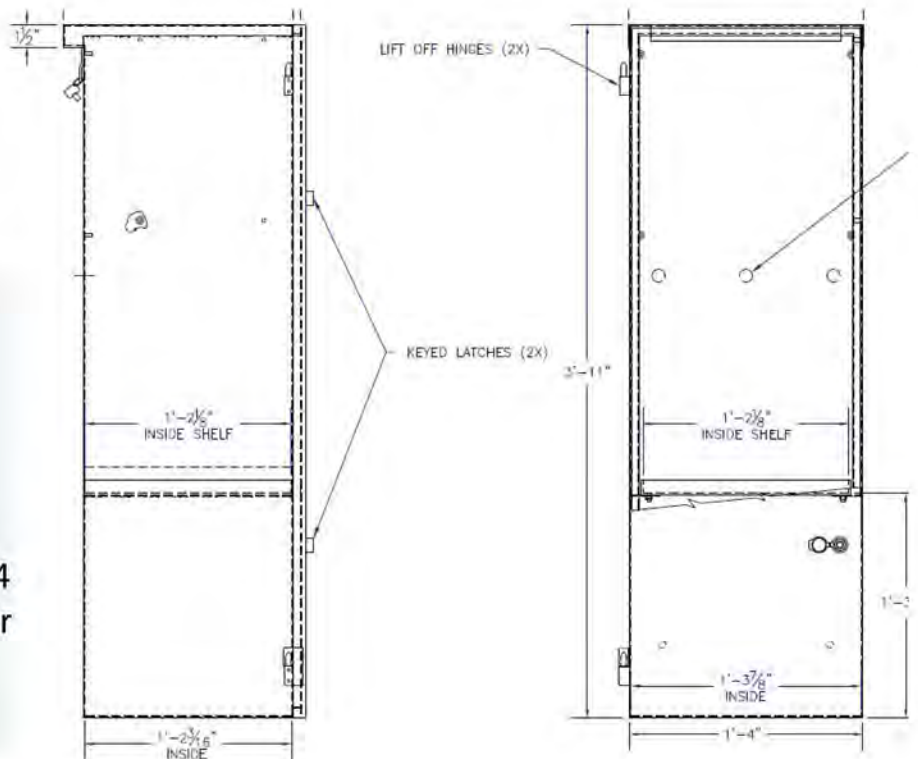

Premium Wide Battery Enclosures: WF Series



Wide battery enclosures to accommodate larger back panels for more support equipment. NEMA3R rated, white powder-coated or mill-finished aluminum enclosure feature hinged, key-lockable doors with dust covers. Passive cooling ventilation with bottom inlet vents and rear-louver outlet vents. The 9" deep cabinets feature: (4) bottom ½" electrical knockouts. The 16" deep cabinets feature: (2) rear ½" and (2) rear 1" electrical knockouts. Standard PRE Control Panels do not fit in WF-Series.

SWPB Part #	Model	Finish	Quantity x Battery Group	Locking Feature	H x W x D (inches)	Weight (lbs.)
004199	WF2	Powder-coated	2 x G31	Keyed latch	30.0 x 27.0 x 9.25	36
004138	WF4	Powder-coated	4 x G31	Keyed latch	30.0 x 27.0 x 16.0	46

Bracket Accessory Options (Sold separately)

SWPB Part#	Model	Finish	Description	H x W x D (inches)	Weight (lbs.)
004386	F-BKTSET	Power-coated	Pole Mounting Bracket	2 x 2 x 13	2.0
004373	PD-MTGBKTSET	Mill-finished	Pad Mounting Bracket	1.6 x 1.6 x 20	4.0

Optional WF-Series Power Electronics Mounting Panels



Panels are made of 0.080" MIN brushed aluminum with mounting holes aligned for enclosure's interior studs.

SWPB Part#	Model	Description	Dimensions H x W (inches)	Weight (lbs.)
007877	WF-RP-D	Rear panel	24.0 x 16.0	2.5

**Extra Space Available
For Power Electronics**



Wide F2 (WF2) Aluminum Enclosure **004199**

WF2 Enclosure with two G31 batteries



The SunWize Power & Battery WF2 aluminum enclosure features a white powder-coated finish and a NEMA3R rating for indoor or outdoor use. The WF2 enclosure can mount on a flat vertical surface or on a variety of pole sizes. It also features hinged, key-lockable doors with dust covers on locks and gasketed door. Passive cooling ventilation. Four bottom 1/2" electrical knockouts.

The WF2 enclosure can hold a variety of battery sizes with plenty of space left over for controls equipment on its backplate. The rear mounted backplate measures 24" x 16", giving it significantly more room than our other standard F-Series enclosures.

30.0"H x 27.0"W x 9.25"D / **36lbs**

WF2 enclosure battery quantities

FEATURES:

- NEMA3R Aluminum Enclosure
- Four 1/2" Knockouts
- Key-lockable door
- Pole or surface mounted

Group Size / BCI No.	Dimensions (L x W x H) inches	Quantity
34	10.00" x 6.88" x 7.63"	2
24	11.13" x 6.60" x 9.25"	2
27	12.00" x 6.63" x 9.06"	2
31	12.9" x 6.75" x 9.27"	2
Oversized G31	13.39" x 6.81" x 11.10"	2
GC2	10.38" x 7.13" x 10.88"	2

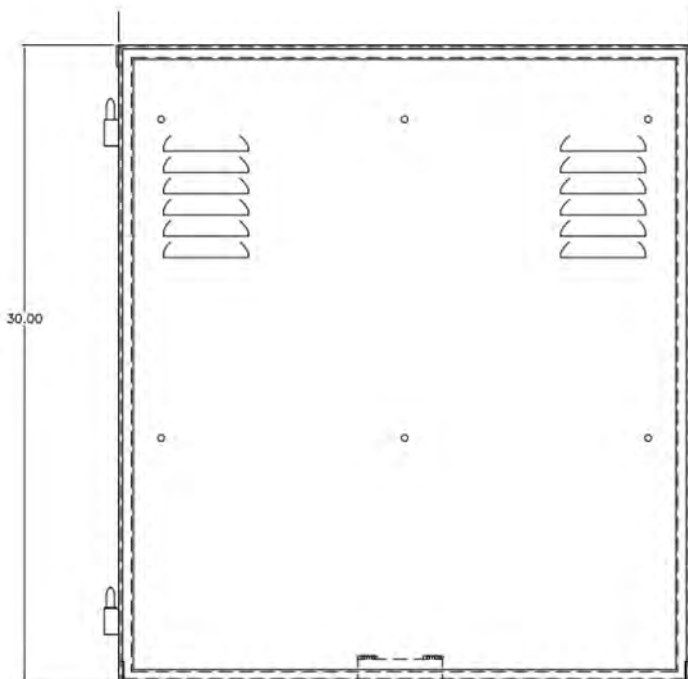

Wide F4 (WF4) Aluminum Enclosure

004138

WF4 Enclosure with four G31 batteries



The SunWize Power & Battery WF4 aluminum enclosure features a white powder-coated finish and a NEMA3R rating for indoor or outdoor use. The WF4 enclosure can mount on a flat vertical surface or on a variety of pole sizes. It also features hinged, key-lockable doors with dust covers on locks and gasketed door. Passive cooling ventilation. Two rear 1/2" electrical knockouts and two rear 1" electrical knockouts.

The WF4 enclosure can hold a variety of battery sizes with plenty of space left over for controls equipment on its backplate. The rear mounted backplate measures 24" x 16", giving it significantly more room than our other standard F-Series enclosures.

30.0"H x 27.0"W x 16.0"D

46lbs

WF4 enclosure battery quantities

Group Size / BCI No.	Dimensions (L x W x H) inches	Quantity
34	10.00" x 6.88" x 7.63"	4
24	11.13" x 6.60" x 9.25"	4
27	12.00" x 6.63" x 9.06"	4
31	12.9" x 6.75" x 9.27"	4
Oversized G31	13.39" x 6.81" x 11.10"	4
GC2	10.38" x 7.13" x 10.88"	2

FEATURES:

- NEMA3R Aluminum Enclosure
- Two 1/2" Knockouts and Two 1" Knockouts
- Key-lockable door
- Pole or surface mounted

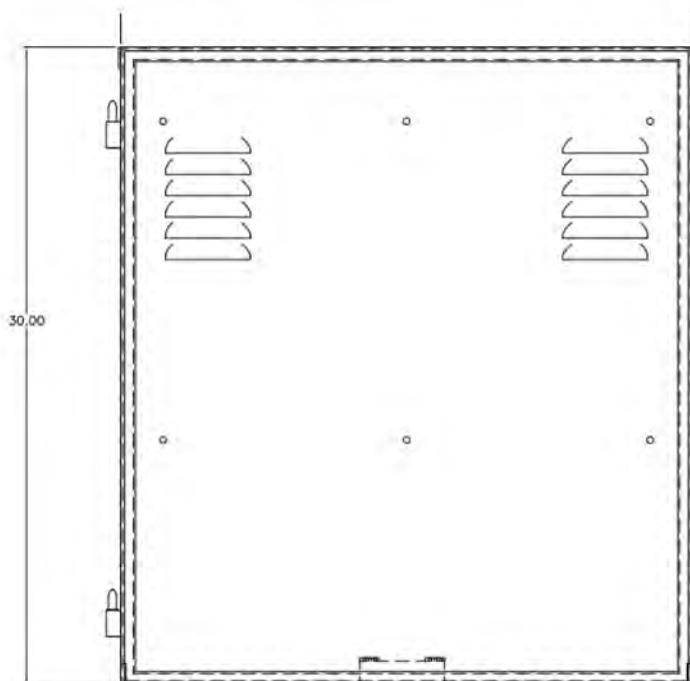

Premium Battery Enclosures: M Series



NEMA3R rated, white powder-coated aluminum enclosures feature hinged, pad-lock latches. Designed for pole or pad mounting options. Locking hinge allows for service of equipment. 3-4 rear-side ½" electrical knockouts plus four bottom-side ½" electrical knockouts. All Power Ready Express (PRE) Control Panels fit in M-Series enclosures.

SWPB Part #	Model	Finish	Quantity x Battery Group	Locking Feature	H x W x D (In.)	Weight (lbs.)
260020	M1-24	Powder-coated	1 x G24	Pad-Lock Latch	14.50" x 11.50" x 7.5"	14
260012	M1-31	Powder-coated	1 x G31	Pad-Lock Latch	20.75" x 16.00" x 9.4"	17
260010	M1-8D	Powder-coated	1 x 8D or 3 x G31	Pad-Lock Latch	20.75" x 24.7" x 14.5"	28
260019	M2-8D	Powder-coated	2 x 8D or 4 x L16	Pad-Lock Latch	36.60" x 25.2" x 14.9"	48

Optional M-Series Power Electronics Mounting Panels



Panels are made of 0.080" MIN brushed aluminum with mounting holes aligned for enclosure's interior studs. Rear panels can be purchased blank or with optional pre-drilled configuration for mounting of control equipment. F-HC-RP-B and F-HC-RP-D are universal fits, accommodating a G31 size battery or larger.

SWPB Part#	Model	Description	Dimensions H x W (inches)	Weight (lbs.)
004228	F-HC-RP-B	Rear panel-blank	15.0 x 6.5	1.0
004237	F-HC-RP-D	Rear panel-drilled	15.0 x 6.5	1.0
004135	BC 45-60	Rear panel-drilled	15.0 x 7.5	1.0
007871	F-HC-RSP-1B	Right side-blank	8.75 x 3.75	0.5
007872	F-HC-RSP-2/4B	Right side-blank	9.25 x 6.25	0.5
250057	M-24-RP	Rear panel-drilled	9.75 x 4.0	0.5
240015	Radio Shelf	Radio Shelf	15.0 x 7.5	1.0



M1-8D - 1x 8D



M2-8D - 2x 8D

M1-24 Aluminum Enclosure **260020**



M1-24 Enclosure fits a single G24 battery

The SunWize Power & Battery M1-24 aluminum enclosure features a white powder-coated finish and a NEMA3R rating for indoor or outdoor use. The M1-24 enclosure can mount on a flat vertical surface or on a variety of pole sizes. It also features pad-lockable lift off doors and passive cooling ventilation.

The M1-24 enclosure can hold a variety of battery sizes with plenty of space left over for controls equipment on its backplate. The 250057 rear mounted backplate measures 9.75" x 4.0". There are four 1/2" knockouts available, two on the back and two on the bottom, for wiring purposes.

FEATURES:

- NEMA3R rated aluminum enclosure
- Four 1/2" Knockouts
- Padlockable door
- Pole or surface mounted
- Uses special 250057 backplate

M1-24 enclosure battery quantities

Group Size / BCI No.	Dimensions (L x W x H) inches	Quantity
U1	7.71" x 5.18" x 6.89"	2
22NF	9.01" x 5.43" x 9.00"	1
24	11.13" x 6.60" x 9.25"	1

Physical Dimensions **11.5"W x 7.5"D x 14.5"H* / 14lbs**

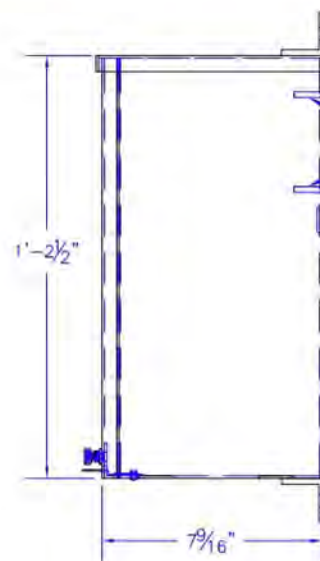
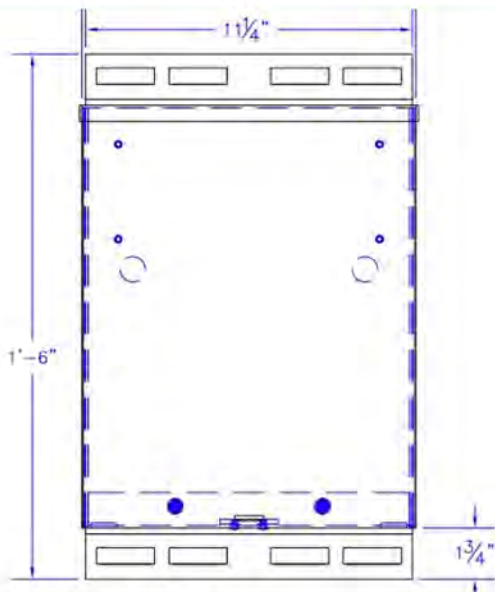

*Height does not include 1 1/8" flange



M1-31 Aluminum Enclosure **260012**



M1-31 Enclosure fits a single G31 battery

The SunWize Power & Battery M1-31 aluminum enclosure features a white powder-coated finish and a NEMA3R rating for indoor or outdoor use. The M1-31 enclosure can mount on a flat vertical surface or on a variety of pole sizes. It also features a padlockable wing latch for added security.

The M1-31 enclosure can hold a variety of battery sizes with plenty of space left over for controls equipment on its back and sideplates. The rear mounted backplate measures 15" x 6.5" and the side mounted backplate measures 8.75" x 3.75". There are seven 1/2" knockouts available, three on the back and four on the bottom, for wiring purposes.

FEATURES:

- NEMA3R rated aluminum enclosure
- Seven 1/2" Knockouts
- Padlockable wing latch
- Pole or surface mounted
- Works with [240015](#) Radio Shelf or [007871](#) Side Plate, not both

M1-31 enclosure battery quantities

Group Size / BCI No.	Dimensions (L x W x H) inches	Quantity
U1	7.71" x 5.18" x 6.89"	3
22NF	9.01" x 5.43" x 9.00"	2
24	11.13" x 6.60" x 9.25"	1
27	12.00" x 6.63" x 9.06"	1
31	12.9" x 6.75" x 9.27"	1

Physical Dimensions **16.00"W x 9.4"D x 20.75"H* / 17lbs**

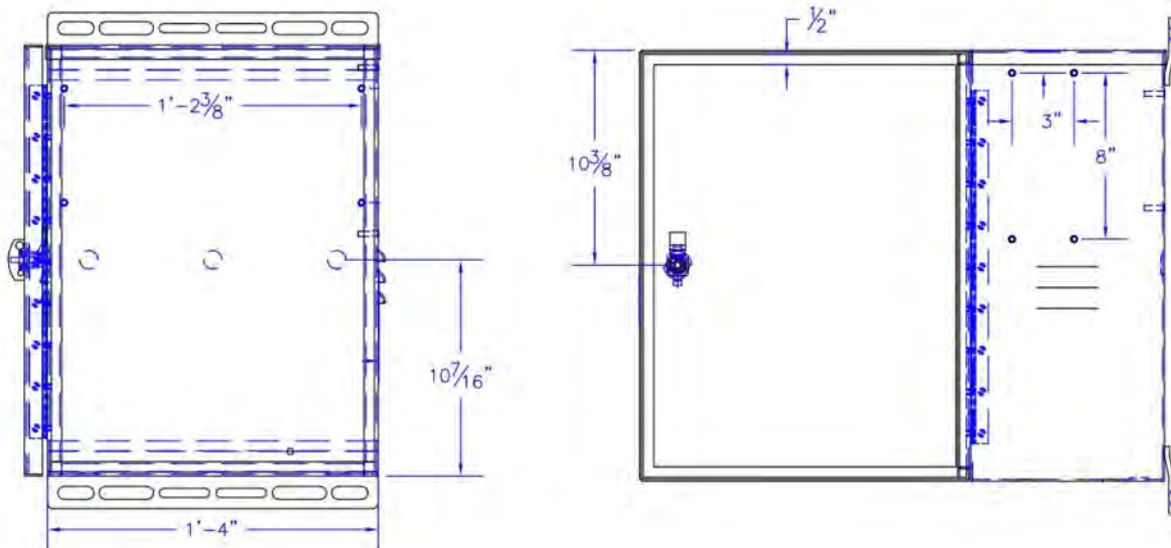

*Height does not include 1/16" flange



M2-31 Aluminum Enclosure **260008**



M2-31 Enclosure fits two G31 batteries

The SunWize Power & Battery M2-31 aluminum enclosure features a white powder-coated finish and a NEMA3R rating for indoor or outdoor use. The M2-31 enclosure can mount on a flat vertical surface or on a variety of pole sizes. It also features a padlockable wing latch for added security.

The M2-31 enclosure can hold a variety of battery sizes with plenty of space left over for controls equipment on its back and sideplates. The rear mounted backplate measures 15" x 6.5" and the side mounted backplate measures 8.75" x 3.75". There are seven 1/2" knockouts available, three on the back and four on the bottom, for wiring purposes.

FEATURES:

- NEMA3R rated aluminum enclosure
- Seven 1/2" Knockouts
- Padlockable wing latch
- Pole or surface mounted
- Works with [240015](#) Radio Shelf or [007871](#) Side Plate, not both

M2-31 enclosure battery quantities

Group Size / BCI No.	Dimensions (L x W x H) inches	Quantity
24	11.13" x 6.60" x 9.25"	2
27	12.00" x 6.63" x 9.06"	2
31	12.9" x 6.75" x 9.27"	2
U1	7.71" x 5.18" x 6.89"	4
40	7.76" x 6.62" x 6.87"	4
22NF	9.01" x 5.43" x 9.00"	3

Physical Dimensions **16.2"W x 15.4"D x 20.8"H* / 22lbs**

*Height does not include 1 3/4" flange

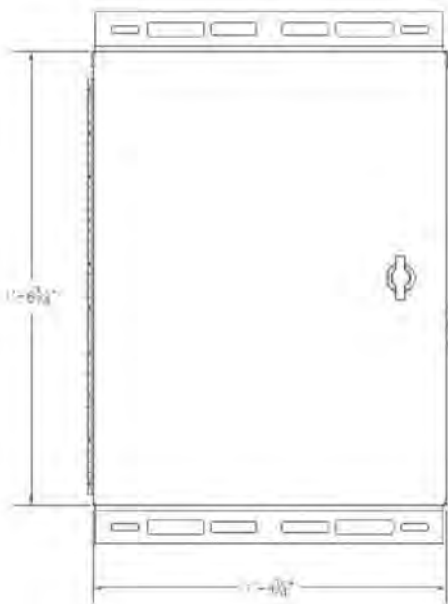

M1-8D Aluminum Enclosure **260010**



M1-8D Enclosure with a single 8D battery

The SunWize Power & Battery M1-8D aluminum enclosure features a white powder-coated finish and a NEMA3R rating for indoor or outdoor use. The M1-8D enclosure can mount on a flat vertical surface or on a variety of pole sizes. It also features a padlockable wing latch for added security.

The M1-8D enclosure can hold a variety of battery sizes with plenty of space left over for controls equipment on its back and sideplates. The rear mounted backplate measures 15" x 6.5" and the side mounted backplate measures 9.25" x 6.25". There are eight 1/2" knockouts available, four on the back and four on the bottom, for wiring purposes.

FEATURES:

- NEMA3R rated aluminum enclosure
- Eight 1/2" Knockouts
- Padlockable wing latch
- Pole or surface mounted
- Works with [240015](#) Radio Shelf and [007872](#) Side Plate simultaneously

M1-8D enclosure battery quantities

Group Size / BCI No.	Dimensions (L x W x H) inches	Quantity
22NF	9.01" x 5.43" x 9.00"	4
24	11.13" x 6.60" x 9.25"	3
27	12.00" x 6.63" x 9.06"	3
31	12.9" x 6.75" x 9.27"	3
4D	20.50" x 8.13" x 10.00"	1
8D	20.75" x 11.00" x 11.00"	1

Physical Dimensions **24.7"W x 14.5"D x 20.75"H* / 28lbs**

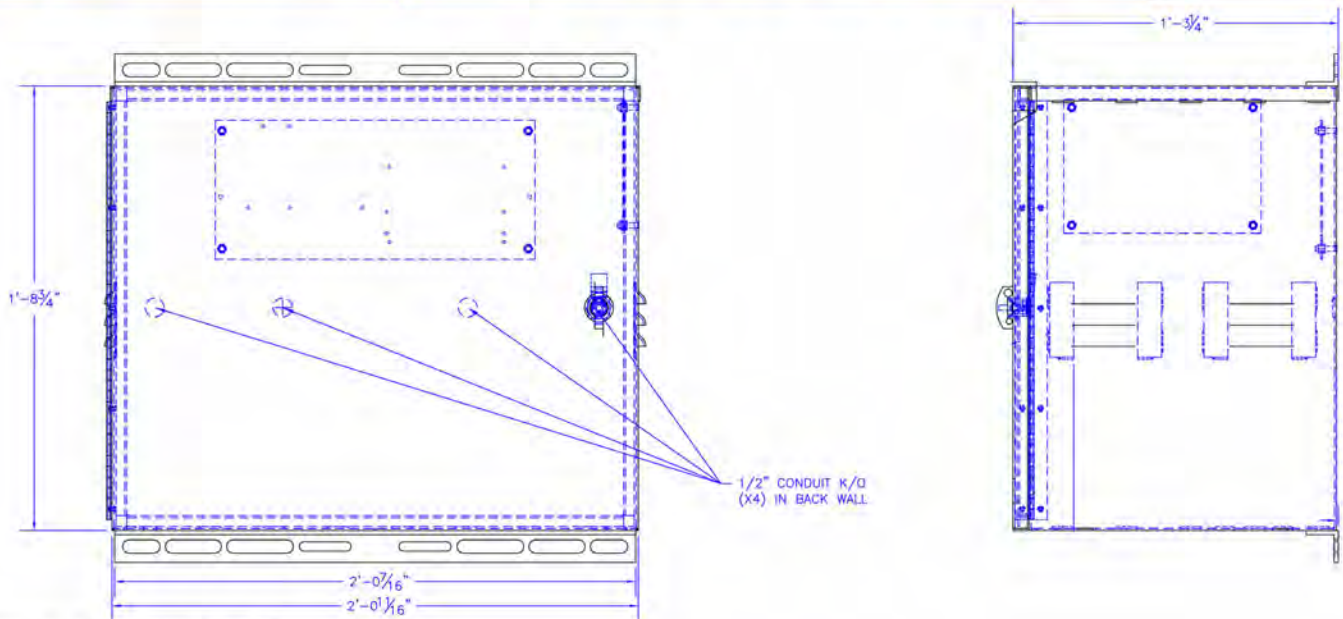

*Height does not include 1/16" flange



M2-8D Aluminum Enclosure **260019**



M2-8D Enclosure with two 8D batteries

FEATURES:

- NEMA3R rated aluminum enclosure
- Eight 1/2" Knockouts
- Padlockable wing latch
- Pole or surface mounted
- Removable Shelf
- Works with [240015](#) Radio Shelf and [007872](#) Side Plate simultaneously

The SunWize Power & Battery M2-8D aluminum enclosure features a white powder-coated finish and a NEMA3R rating for indoor or outdoor use. The M2-8D enclosure can mount on a flat vertical surface or on a variety of pole sizes. It also features a padlockable wing latch for added security.

The M2-8D enclosure can hold a variety of battery sizes with plenty of space left over for controls equipment on its back and sideplates. The rear mounted backplate measures 15" x 6.5" and the side mounted backplate measures 9.25" x 6.25". There are eight 1/2" knockouts available, four on the back and four on the bottom, for wiring purposes.

M2-8D enclosure battery quantities

Group Size / BCI No.	Dimensions (L x W x H) inches	Quantity
24	11.13" x 6.60" x 9.25"	6
27	12.00" x 6.63" x 9.06"	6
31	12.9" x 6.75" x 9.27"	6
L16	11.6" x 7.1" x 16.8"	4
4D	20.50" x 8.13" x 10.00"	2
8D	20.75" x 11.00" x 11.00"	2

Physical Dimensions 25.2"W x 14.9"D x 36.6"H* 48lbs

*Height does not include 1/16" flange

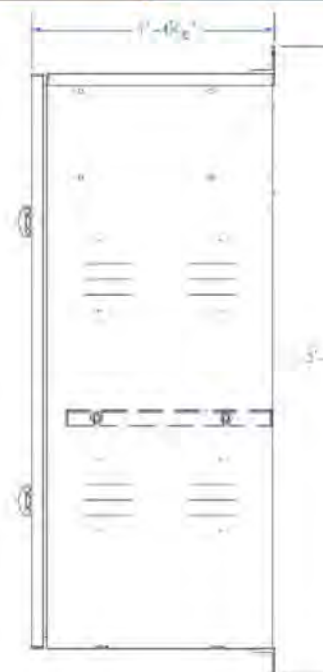
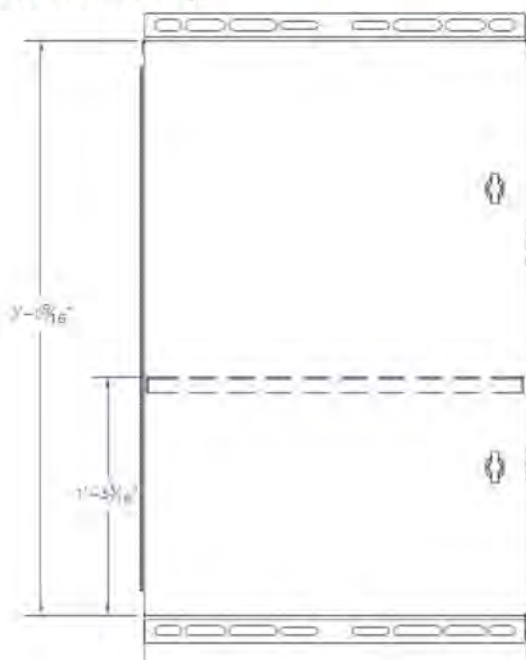

Headquarters
30893 Ehlen Dr Sw
Albany, OR 97321
(866) 827-6527



Economy Battery Enclosures: C Series



Aluminum enclosures feature removable covers with stainless steel screws. NEMA3R rated, mill-finished metal enclosures with (2) rear ½” electrical knockouts and rear louver vents. All Power Ready Express (PRE) Control Panels fit in C-Series enclosures.

(C Series Enclosures – Economy Bracket Set – Sold Separately)

SWPB Part #	Model	Finish	Quantity x Battery Group	Locking Feature	H x W x D (Inches)	Weight (lbs.)
004160	C1-125	Mill-finished	1 x G31	Pad-Lock hasp	17.0 x 16.0 x 9.38	12
004142	C2-250	Mill-finished	2 x G31	Pad-Lock hasp	17.0 x 16.0 x 14.38	17
004143	C4-500	Mill-finished	4 x G31	Pad-Lock hasp	32.0 x 16.0 x 14.38	25

C Series Bracket Accessory Options

SWPB Part#	Model	Finish	Description	H x W x D (inches)	Weight (lbs.)
004387	E-BKTSET	Mill-finished	Pole Mounting Bracket	2 x 2 x 13	2.0
004373	PD-MTGBKTSET	Mill-finished	Pad Mounting Bracket	1.6 x 1.6 x 20	4.0

Optional C-Series Power Electronics Mounting Panels



Panels are made of 0.080” MIN brushed aluminum with mounting holes aligned for enclosure’s interior studs. Rear panels can be purchased blank or with optional pre-drilled configuration for mounting of control equipment. F-HC-RP-B and F-HC-RP-D are universal fits, accommodating a G31 size battery or larger.

SWPB Part#	Model	Description	Dimensions H x W (inches)	Weight (lbs.)
004228	F-HC-RP-B	Rear panel-blank	15.0 x 6.5	1.0
004237	F-HC-RP-D	Rear panel-drilled	15.0 x 6.5	1.0
004135	BC 45-60	Rear panel-drilled	15.0 x 7.5	1.0
240015	Radio Shelf	Radio Shelf	15.0 x 7.5	1.0



C1-125



C2-250



C4-500

C1-125 Aluminum Enclosure **004160**

C1-125 Enclosure with one G31 battery



The SunWize Power & Battery C1-125 aluminum enclosure features a mill-finish and a NEMA3R rating for indoor or outdoor use. The C1-125 enclosure can mount on a flat vertical surface or on a variety of pole sizes. It also features pad-lockable lift off doors and passive cooling ventilation.

The C1-125 enclosure can hold a variety of battery sizes with plenty of space left over for controls equipment on its backplate. The rear mounted backplate measures 15" x 6.5". There are two 1/2" knockouts available on the back for wiring purposes.

17.0"H x 16.0"W x 9.38"D / **12lbs**

FEATURES:

- NEMA3R Aluminum Enclosure
- Two 1/2" Knockouts
- Pad-lockable door
- Pole or surface mounted
- Works with [240015](#) Radio Shelf

C1-125 enclosure battery quantities

Group Size / BCI No.	Dimensions (L x W x H) inches	Quantity
U1	7.71" x 5.18" x 6.89"	2
40	7.76" x 6.62" x 6.87"	2
22NF	9.01" x 5.43" x 9.00"	2
34	10.00" x 6.88" x 7.63"	2
24	11.13" x 6.60" x 9.25"	1
27	12.00" x 6.63" x 9.06"	1
31	12.9" x 6.75" x 9.27"	1



C2-250 Aluminum Enclosure **004142**

C2-250 Enclosure with two G31 batteries



The SunWize Power & Battery C2-250 aluminum enclosure features a mill-finish and a NEMA3R rating for indoor or outdoor use. The C2-250 enclosure can mount on a flat vertical surface or on a variety of pole sizes. It also features pad-lockable lift off doors and passive cooling ventilation.

The C2-250 enclosure can hold a variety of battery sizes with plenty of space left over for controls equipment on its backplate. The rear mounted backplate measures 15" x 6.5". There are two 1/2" knockouts available on the back for wiring purposes.

17.0"H x 16.0"W x 14.38"D / **17lbs**

C2-250 enclosure battery quantities

Group Size / BCI No.	Dimensions (L x W x H) inches	Quantity
U1	7.71" x 5.18" x 6.89"	4
40	7.76" x 6.62" x 6.87"	4
22NF	9.01" x 5.43" x 9.00"	4
34	10.00" x 6.88" x 7.63"	4
24	11.13" x 6.60" x 9.25"	2
27	12.00" x 6.63" x 9.06"	2
31	12.9" x 6.75" x 9.27"	2

FEATURES:

- NEMA3R Aluminum Enclosure
- Two 1/2" Knockouts
- Pad-lockable door
- Pole or surface mounted
- Works with [240015](#) Radio Shelf



C4-500 Aluminum Enclosure **004143**

C4-500 Enclosure with four G31 batteries



The SunWize Power & Battery C4-500 aluminum enclosure features a mill-finish and a NEMA3R rating for indoor or outdoor use. The C4-500 enclosure can mount on a flat vertical surface or on a variety of pole sizes. It also features pad-lockable lift off doors and passive cooling ventilation.

The C4-500 enclosure can hold a variety of battery sizes with plenty of space left over for controls equipment on its backplate. The rear mounted backplate measures 15" x 6.5". There are two 1/2" knockouts available on the back for wiring purposes.

32.0"H x 16.0"W x 14.38"D / **25lbs**

FEATURES:

- NEMA3R Aluminum Enclosure
- Two 1/2" Knockouts
- Pad-lockable door
- Pole or surface mounted
- Works with [240015](#) Radio Shelf
- Removable Shelf

C4-500 enclosure battery quantities

Group Size / BCI No.	Dimensions (L x W x H) inches	Quantity
24	11.13" x 6.60" x 9.25"	4
27	12.00" x 6.63" x 9.06"	4
31	12.9" x 6.75" x 9.27"	4



Economy Battery Enclosures: E Series



Aluminum enclosures feature removable covers with stainless steel screws. NEMA3R rated, mill-finished metal enclosures include an external mounting tab for 2" pipe U-bolts. Power Ready Express (PRE) Control Panels do not fit in our E-Series enclosures.

E1-63 features small back panel for mounting electronics. E1-38 has no back panel.

(E Series Enclosures – No Bracket Option)

SWPB Part #	Model	Finish	Quantity x Battery Group	Locking Feature	H x W x D (inches)	Weight (lbs.)
004141	E1-38	Mill-finished	1 x GU1	Pad-Lock hasp	11.25 x 9.1 x 5.6	4
004158	E1-63	Mill-finished	1 x G22NF	Pad-Lock hasp	14.5 x 10.3 x 7.5	6



The SunWize Power & Battery E1-38 is a versatile mill-finish enclosure that can serve as a small self-contained battery box, a combiner box, or many other purposes. Three bottom 1/2" knockouts, two rear 1/2" knockouts, and two side 1/2" knockouts.

The E1-38 is designed to fit one GU1 battery only.
E1-38 enclosure battery quantities

Group Size / BCI No.	Dimensions (L x W x H) inches	Quantity
U1	7.71" x 5.18" x 6.89"	1

The SunWize Power & Battery E1-63 is a versatile mill-finish enclosure that can serve as a small self-contained battery box, a combiner box, or many other purposes. Two bottom 1/2" knockouts and two rear 1/2" knockouts.

The E1-63 is designed to fit two GU1 batteries or one 22NF battery with additional room for controls on a small back panel.

E1-63 enclosure battery quantities

Group Size / BCI No.	Dimensions (L x W x H) inches	Quantity
U1	7.71" x 5.18" x 6.89"	2
22NF	9.01" x 5.43" x 9.00"	1



SHOP NOW



Headquarters
30893 Ehlen Dr Sw
Albany, OR 97321
(866) 827-6527



Premium Battery Enclosures: T Series



NEMA3R rated, white powder-coated aluminum enclosures feature hinged, pad-lockable lids. Locking hinge allows for service of equipment. Elevated skid feet, (2) left-side 1/2" electrical knockouts. All T-Series enclosures can install onto our Power Station A-Frame structures or be ground mounted. All Power Ready Express (PRE) Control Panels fit in T-Series enclosures.

SWPB Part #	Model	Finish	Quantity x Battery Group	Locking Feature	H x W x D (inches)	Weight (lbs.)
004230	T-2X8D	Powder-coated	2 x 8D or 3 x 4D	Pad-Lock hasp	20.25 x 31.25 x 23.75	55
004140	T-4X8D	Powder-coated	4 x 8D or 4 x 4D	Pad-Lock hasp	20.25 x 48.25 x 23.75	75
016897	T-8X8D	Powder-coated	8 x 8D or 16 x L16	Pad-Lock hasp	20.25 x 48.25 x 46.00	150

Optional T-Series Power Electronics Mounting Panels



Panels are made of 0.080" MIN brushed aluminum with mounting holes aligned for enclosure's interior studs. Rear panels can be purchased blank or with optional pre-drilled configuration for mounting of control equipment. F-HC-RP-B and F-HC-RP-D are universal fits. The optional top-mounting plate is for T-Series only.

SWPB Part#	Model	Description	Dimensions H x W (inches)	Weight (lbs.)
004228	F-HC-RP-B	Rear panel-blank	15.0 x 6.5	1.0
004237	F-HC-RP-D	Rear panel-drilled	15.0 x 6.5	1.0
004135	BC 45-60	Rear panel-drilled	15.0 x 7.5	1.0
004198	MP-T	Top Mounting Plate	17.0 x 17.0	3.0



T-4X8D



T-2X8D



T-8X8D

T-2X8D Aluminum Enclosure **004230**

T-2X8D Enclosure with three 4D batteries



The SunWize Power & Battery T-2X8D aluminum enclosure features a white powder-coated finish and a NEMA3R rating for indoor or outdoor use. The T-2X8D enclosure can mount on any flat surface. It also features a hinged, pad-lockable door and passive cooling ventilation. Two left side 1/2" electrical knockouts.

The T-2X8D enclosure can hold a variety of battery sizes with plenty of space left over for controls equipment on its backplate. The side mounted backplate measures 15" x 6.5" and the optional top mounted backplate measures 17.0" x 17.0".

20.25"H x 31.25"W x 23.75"D / 55lbs

T-2X8D enclosure battery quantities

Group Size / BCI No.	Dimensions (L x W x H) inches	Quantity
4D	20.50" x 8.13" x 10.00"	3
8D**	20.75" x 11.00" x 11.00"	2
GC2	10.38" x 7.13" x 10.88"	2
L16	11.64" x 6.95" x 15.73"	4

****Control panel depth limitations**

FEATURES:

- NEMA3R Aluminum Enclosure
- Two 1/2" Knockouts
- Pad-lockable door
- Surface mounted
- Elevated skid feet
- Works with Optional panel part

[004198](#)



T-4X8D Aluminum Enclosure **004140**

T-4X8D Enclosure with four 4D batteries



The SunWize Power & Battery T-4X8D aluminum enclosure features a white powder-coated finish and a NEMA3R rating for indoor or outdoor use. The T-4X8D enclosure can mount on any flat surface. It also features a hinged, pad-lockable door and passive cooling ventilation. Two left side 1/2" electrical knockouts.

The T-4X8D enclosure can hold a variety of battery sizes with plenty of space left over for controls equipment on its backplate. The side mounted backplate measures 15" x 6.5" and the optional top mounted backplate measures 17.0" x 17.0".

20.25"H x 48.25"W x 23.75"D / 75lbs

FEATURES:

- NEMA3R Aluminum Enclosure
- Two 1/2" Knockouts
- Pad-lockable door
- Surface mounted
- Elevated skid feet
- Works with Optional panel part [004198](#)

T-4X8D enclosure battery quantities

Group Size / BCI No.	Dimensions (L x W x H) inches	Quantity
4D	20.50" x 8.13" x 10.00"	4
8D**	20.75" x 11.00" x 11.00"	4
GC2	10.38" x 7.13" x 10.88"	4
L16	11.64" x 6.95" x 15.73"	8

****Control panel depth limitations**



T-8X8D Aluminum Enclosure **016897**

T-8X8D Enclosure with eight 8D batteries



The SunWize Power & Battery T-8X8D aluminum enclosure features a white powder-coated finish and a NEMA3R rating for indoor or outdoor use. The T-8X8D enclosure can mount on any flat surface. It also features a hinged, pad-lockable door and passive cooling ventilation. Two left side 1/2" electrical knockouts.

The T-8X8D enclosure can hold a variety of battery sizes with plenty of space left over for controls equipment on its backplate. The side mounted backplate measures 15" x 6.5" and the optional top mounted backplate measures 17.0" x 17.0".

20.5"H x 48.3"W x 46.0"D / 150lbs

FEATURES:

- NEMA3R Aluminum Enclosure
- Two 1/2" Knockouts
- Pad-lockable door
- Surface mounted
- Elevated skid feet
- Works with Optional panel part [004198](#)

T-8X8D enclosure battery quantities

Group Size / BCI No.	Dimensions (L x W x H) inches	Quantity
4D	20.50" x 8.13" x 10.00"	10
8D**	20.75" x 11.00" x 11.00"	8
GC2	10.38" x 7.13" x 10.88"	8
L16	11.64" x 6.95" x 15.73"	16

****Control panel depth limitations**



UPS Style Enclosure **260004**



UPS style enclosure targeted for battery backup system applications. NEMA3R rated, white powder-coated aluminum enclosures feature hinged, key lockable doors with dust covers on locks and gasketed door. Passive cooling ventilation. Three 1-1/2" electrical knockouts per side. Significant space for controls allows up to (16) customer load breakers, plus multiple battery chargers and/or controllers. Power Ready Express (PRE) Control Panels do not fit in UPS style enclosure.

SWPB Part #	Primary Purpose	Features & Attributes	H x W x D (inches)	Weight (lbs)
260004	Inverter/Electronics UPS Cabinet	(1) or (2) movable shelves to accommodate battery heights, Maximum battery counts: 18xG27, 18xG31, 12xL16, 8x4D, 6x8D, Large Electronics Mounting Panel, Strut for mounting DIN Rail, Mount for battery disconnect breaker	66.0 x 36.0 x 24.75	195
260017	UPS-BH	Bottom Half - 8x4D, 6x8D or 16xL16 Batteries	46.8 x 36.0 x 25.8	132
260018	UPS-TH	Top Half - Electronics Area	19.1 x 36.0 x 25.9	60

FEATURES:

- NEMA3R Aluminum Enclosure
- Six 1-1/2" Knockouts
- Key-lockable door
- Surface mounted
- Removable Shelf

UPS enclosure battery quantities

Group Size / BCI No.	Dimensions (L x W x H) inches	Quantity
4D	20.50" x 8.13" x 10.00"	8
8D	20.75" x 11.00" x 11.00"	6
GC2	10.38" x 7.13" x 10.88"	8
L16	11.64" x 6.95" x 15.73"	16



Mounting Tabs on Deadfront for DIN Breakers

SHOP NOW



Headquarters
30893 Ehlen Dr Sw
Albany, OR 97321
(866) 827-6527



Pole Mounting Bracket for F, WF and C Series Enclosures



Aluminum brackets feature a slot design allowing use of 2" – 8" pipe diameter U-Bolts or band clamps, and a slot that allows up to 1" thick banding for large diameter pole mounting. Brackets feature tamper-resistant design and include stainless steel mounting hardware (U-bolts not included).

SWPB Part#	Model	Finish	Description	Dimensions H x W x D (inches)	Weight (lbs.)
004386	F-BKTSET	Power-coated	Premium	2 x 2 x 13	2.0
004387	E-BKTSET	Mill-finished	Economy	2 x 2 x 13	2.0

Pad Mounting Brackets for F and C Series Enclosures



Pre-cut aluminum channel allows the enclosure to be mounted to the ground without impeding door operation or ventilation. Model PD-MTGKSET includes (2) pre-cut and drilled struts and mounting hardware to mount the enclosure to the bracket.

SWPB Part#	Model	Description	Dimensions H x W x D (inches)	Weight (lbs.)	Enclosure Type
004373	PD-MTGKSET	Pad Mounting Bracket	1.6 x 1.6 x 20	4.0	F & C Series

Base Stand for M2-8D Enclosure



Powder-coated aluminum base stand elevates M2-8D enclosure 12.0" inches off the ground. Features (4) pre-drilled bolt holes to securely fasten the stand to the ground. Mounting hardware not included.

SWPB Part#	Model	Description	Dimensions H x W x D (inches)	Weight (lbs.)	Enclosure Type
250097	M28D Base	Base stand	12.0 x 14.76 x 25.19	12.0	M2-8D

Power Electronics Mounting Panels



Panels are made of 0.080" MIN brushed aluminum with mounting holes aligned for enclosure's interior studs. Rear panels can be purchased blank or with optional pre-drilled configuration for mounting of control equipment. F-HC-RP-B and F-HC-RP-D are universal fits, accommodating a G31 size battery or larger. F-HC-RSP models for use in F-series enclosures only.

SWPB Part#	Model	Description	Dimensions H x W (inches)	Weight (lbs.)
004228	F-HC-RP-B	Rear panel-blank	15.0 x 6.5	1.0
004237	F-HC-RP-D	Rear panel-drilled	15.0 x 6.5	1.0
007871	F-HC-RSP-1B	Right side-blank	8.75 x 3.75	0.5
007872	F-HC-RSP-2/4B	Right side-blank	9.5 x 6.25	0.5
250004	F-HC-RP-TF4	Rear panel-blank	15.4 x 13.25	2.0
004135	BC 45-60	Rear panel-drilled	15.0 x 7.5	1.0
004198	MP-T	Top Mounting Plate	17.0 x 17.0	3.0
007877	WF-RP-D	Rear panel-drilled	24.0 x 16.0	2.5
240015	Radio Shelf	Radio Shelf	15.0 x 7.5	1.0

SHOP NOW



Headquarters
30893 Ehlen Dr Sw
Albany, OR 97321
(866) 827-6527



Power Electronics Back Mounting Panels, F/M/C/T Series

SunWize® Enclosures feature a variety of mounting plate options for various electronics, including solar charge controllers, breakers, and various other power conditioning equipment. Every enclosure except the E1-38 features a standard backplate for mounting electronics equipment. Various enclosures also feature space for an extra side mounting plate, which gives even more room for custom electronics or equipment. Some enclosures support both a side plate and a radio shelf simultaneously, while others will support only a single side plate or a single radio shelf at a time.

Universal Backplates



Blank



Drilled



004135 BC 45-60

Compatible Enclosures (*M-Series, F-Series, C-Series, T-Series):

- [260012](#) - M1-31
- [260010](#) - M1-8D
- [260019](#) - M2-8D
- [004154](#) - F1
- [004219](#) - F2
- [004222](#) - F4
- [004160](#) - C1-125
- [004142](#) - C2-250
- [004143](#) - C4-500
- [004230](#) - T-2X8D
- [004140](#) - T-4X8D
- [016987](#) - T-8X8D

*M1-24 Not Included



Technical Specifications

	250025 (PRE drill pattern) 004237	004228	004135
Physical Dimensions			
Width	15 inches	15 inches	15 inches
Depth	6.5 inches	6.5 inches	7.5 inches
Thickness	1/8 inch	1/8 inch	1/8 inch
Material	Aluminum	Aluminum	Aluminum
Finish	Mill-Finish	Mill-Finish	Mill-Finish



***Standard backplates do not include switchgear. shown for info.
 For pre-wired backplates, see our control panels section**

SHOP NOW



Headquarters
 30893 Ehlen Dr Sw
 Albany, OR 97321
 (866) 827-6527



Power Electronics Side Mounting Panels, F/M Series

SunWize® Enclosures feature a variety of mounting plate options for various electronics, including solar charge controllers, breakers, and various other power conditioning equipment. SunWize side mounting plates gives even more room for custom electronics or equipment. Our F-Series and M-Series enclosures both support Sideplates, in addition to the standard Backplates.

Sideplates



1 Battery Sideplate



2/4 Battery Sideplate

007871 - Compatible Enclosures (M-Series, F-Series):

- [260012](#) - M1-31
- [004154](#) - F1

007872 - Compatible Enclosures (M-Series, F-Series):

- [260010](#) - M1-8D
- [004219](#) - F2
- [260019](#) - M2-8D
- [004222](#) - F4

250005 - 9.5" x 13.25"- Compatible Enclosure:

- [260003](#) - F4-Tall



Technical Specifications

Physical Dimensions	007871	007872
Width	8.75 inches	9.25 inches
Depth	3.75 inches	6.25 inches
Thickness	1/8 inch	1/8 inch
Material	Aluminum	Aluminum
Finish	Mill-Finish	Mill-Finish

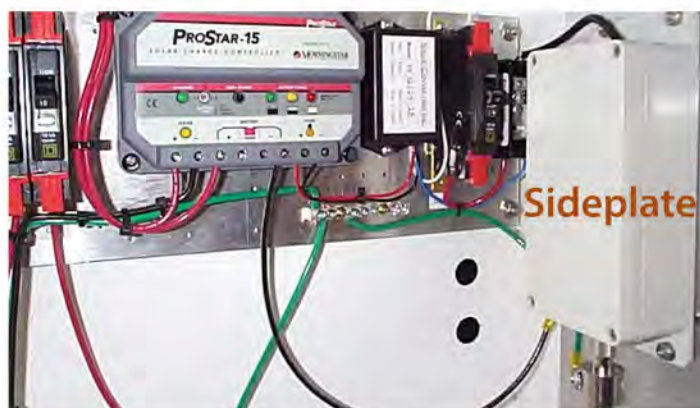

SHOP NOW



Headquarters
 30893 Ehlen Dr Sw
 Albany, OR 97321
 (866) 827-6527



Power Electronics WF-Series Back Mounting Panels

SunWize® WF-Series Enclosures feature extra-large mounting plate options for various electronics, including solar charge controllers, breakers, and various other power conditioning equipment. SunWize WF-Series mounting plates give extra room for custom electronics or equipment compared to our F-Series and C-Series enclosures.

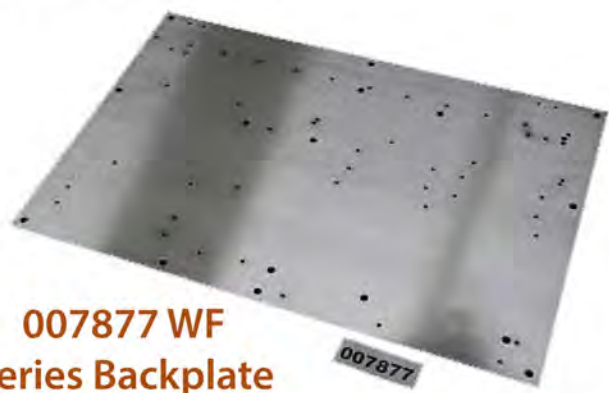

007877 WF Series Backplate

007877 - Compatible Enclosures (WF-Series):

- [004199](#) - WF2
- [004138](#) - WF4



Mounted Backplate Example 1

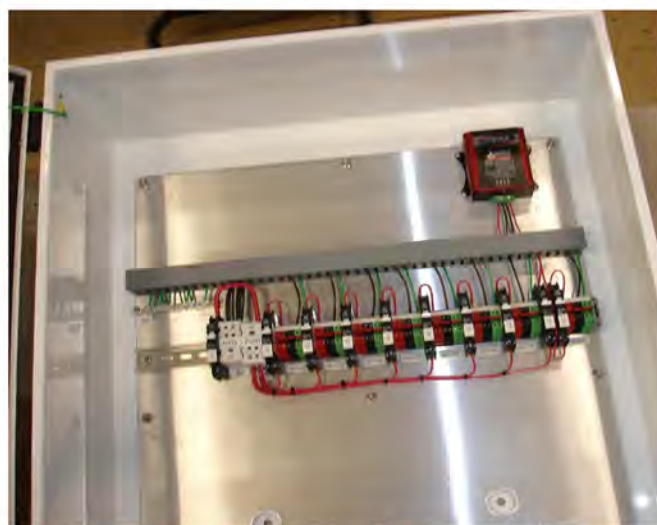

Mounted Backplate Example 2

Technical Specifications

Physical Dimensions [007877](#)

Width	24.00 inches
Depth	16.00 inches
Thickness	1/8 inch
Material	Aluminum
Finish	Mill-Finish



SHOP NOW



Headquarters
30893 Ehlen Dr Sw
Albany, OR 97321
(866) 827-6527



Power Electronics T-Series Back & Top Mounting Panels

SunWize® T-Series Enclosures feature several mounting options for various electronics, including solar charge controllers, breakers, and other power conditioning equipment. SunWize T-Series enclosures fit with our universal backplates 004228 and 004237, which includes all Power Ready Express (PRE) Control Panels. In addition, they're compatible with our larger sized 004135 and 004198 backplates.

If additional mounting area is required, there is an optional top-mounting plate available, call for inquiry.



004135 Universal Backplate



004198 Optional Large Mounting

Compatible Enclosures (T-Series):

- [004230](#) - T-2X8D
- [004140](#) - T-4X8D
- [016987](#) - T-8X8D



Mounted Backplate Example

Technical Specifications

Physical Dimensions	004135	004198
Width	15.00 inches	17.00 inches
Depth	7.5 inches	17.00 inches
Thickness	1/8 inch	1/8 inch
Material	Aluminum	Aluminum
Finish	Mill-Finish	Mill-Finish



SHOP NOW



Headquarters
 30893 Ehlen Dr Sw
 Albany, OR 97321
 (866) 827-6527



Enclosure Radio Shelf

240015

The SunWize® Radio Shelf provides a convient surface for placing or mounting extra electronics and equipment inside an enclosure. It easily mounts to the front of a PR Express Control Panel or other similarly sized backplate. The Radio Shelf is great for radios, cellular modems, data loggers, inverters and more. Some enclosures support both a radio shelf and PRE Accessory panels, see enclosure datasheets for full details.



Compatible Enclosures (M-Series, F-Series, C-Series):

- [260012](#) - M1-31
- [260010](#) - M1-8D**
- [260019](#) - M2-8D**
- [004154](#) - F1
- [004219](#) - F2
- [004222](#) - F4
- [260003](#) - F4-Tall
- [004160](#) - C1-125
- [004142](#) - C2-250
- [004143](#) - C4-500

****Will fit Sideplate & Radio Shelf simultaneously**



Technical Specifications

Physical Dimensions

Width	15 inches
Depth	8 inches
Thickness	1/8 inch
Material	Aluminum
Finish	Mill-Finish



SHOP NOW



Headquarters
 30893 Ehlen Dr Sw
 Albany, OR 97321
 (866) 827-6527



PWM Power Ready Express (PRE) Control Panels



PRE Control Panel with a 10 amp SunSaver

FEATURES:

- Pre-drilled aluminum backplate
- Pre-wired and fully assembled
- Three (3) load connections
- Separate breakers for the array, battery and load
- Fits with all F/M/C/T Series Enclosures

SunWize Power & Battery PR Express Control Panels are pre-wired aluminum panels for Power Ready Express systems. These control panels use our Universal Backplate 250025, which is like our 004237 but with different hole pattern. They have all of the necessary switchgear and termination wires to hook up a solar array and battery bank easily.

The control panel consists of a backplate; a charge controller; two load terminals; and breakers for the array, battery and load. All breakers are sized to match the rating of the charge controller.



PRE Control Panel with a 30 amp ProStar

Technical Specifications

	<u>230031</u>	<u>230032</u>	<u>230033</u>	<u>230034</u>	<u>230035</u>	<u>230036</u>	<u>230037</u>
Battery Voltage	12	12	12	12	24	10	24
Current Rating	6	6	10	10	10	20	20
LVD		X		X	X	X	X
Maximum Array Voc	30	30	30	30	60	30	60
Charge Controller	SunSaver SS-6-12V	SunSaver SS-6L-12V	SunSaver SS-10-12V	SunSaver SS-10L-12V	SunSaver SS-10L-24V	SunSaver SS-20L-12V	SunSaver SS-20L-24V

	<u>230038</u>	<u>230039</u>	<u>230041</u>	<u>230042</u>
Battery Voltage	12/24	12/24	12/24	12/24
Current Rating	15	15	30	30
LVD	X	X	X	X
Maximum Array Voc	60	60	60	60
Charge Controller	ProStar PS-15	ProStar PS-15M	ProStar PS-30	ProStar PS-30M



SHOP NOW



Headquarters
30893 Ehlen Dr Sw
Albany, OR 97321
(866) 827-6527



MPPT Power Ready Express (PRE) Control Panels

SunWize Power & Battery PR Express Control Panels are prewired aluminum panels for Power Ready Express systems. These control panels use our Universal Backplate 250025, which is like our 004237 but with a different hole pattern.

They have all of the necessary switchgear to hook up a charge/load controller to a solar array, battery bank and load. The MPPT versions can use the power from the solar array more efficiently than the standard PR Express control panels and have additional features.



PRE Control Panel with a 25 amp MPPT ProStar with meter

FEATURES:

- Pre-drilled aluminum backplate
- Pre-wired and fully assembled
- Three (3) load connections
- Separate breakers for the array, battery and load
- Fits with all F/M/C/T Series Enclosures

MPPT FEATURES:

- Increases solar array production 3-5%
- Advanced Lighting control
- Load high voltage disconnect
- Data logging
- MODBUS communication for data retrieval and remote access

The control panel consists of a backplate; a charge controller; two load terminals; and breakers for the array, battery and load. All breakers are sized to match the rating of the charge controller.

Technical Specifications

	<u>230054</u>	<u>230055</u>	<u>230057</u>	<u>230058</u>	<u>230067</u>
Battery Voltage	12/24	12/24	12/24	12/24	12/24
Maximum Array Voltage (Voc)	120	120	120	120	60
Current Rating	25	40	25	40	15
Self Consumption	0.6W, Max 1W	0.6W, Max 1W	0.6W, Max 1W	0.6W, Max 1W	35 milliamps
Low Voltage Disconnect (LVD)	X	X	X	X	X
Digital Display	X	X			
Charge Controller	ProStar PS-MPPT-25M	ProStar PS-MPPT-40M	ProStar PS-MPPT-25	ProStar PS-MPPT-40	SunSaver SS-MPPT-15L

SHOP NOW



Headquarters
30893 Ehlen Dr Sw
Albany, OR 97321
(866) 827-6527



Phocos Power Ready Express (PRE) Control Panels



PRE Control Panel with a 10 amp ECO-N-T

SunWize Power & Battery PR Express Control Panels are prewired aluminum panels for Power Ready Express systems. They have all of the necessary switchgear to hook up a charge/load controller to a solar array, battery bank and load. These control panels use our Universal Backplates 250025, which is like our 004237 but with different hole pattern.

The control panel consists of a backplate; a charge controller; two load terminals; and breakers for the array, battery and load. All breakers are sized to match the rating of the charge controller.

FEATURES:

- Pre-drilled aluminum backplate
- Pre-wired and fully assembled
- Three (3) load connections
- Separate breakers for the array, battery and load
- Fits with all F/M/C/T Series Enclosures



PRE Control Panel with a 20 amp DINGO

Technical Specifications

	<u>230073</u>	<u>230075</u>	<u>230076</u>
Voltage	12/24/48	12/24	12/24
Current Rating	20	10	20
LVD	Yes	Yes	Yes
Digital Display	Yes	No	No
Charge Controller	DINGO D2020N	ECO ECO-N-10-T	ECO ECO-N-20-T

SHOP NOW



Headquarters
30893 Ehlen Dr Sw
Albany, OR 97321
(866) 827-6527

